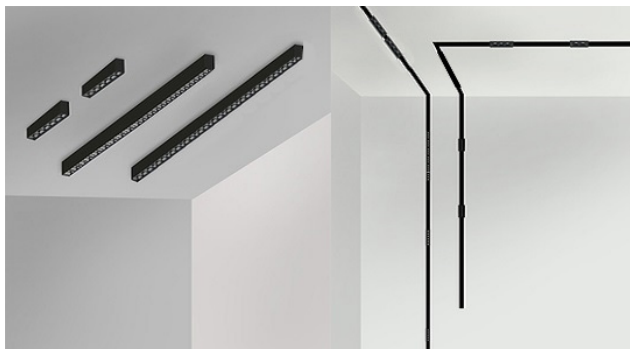
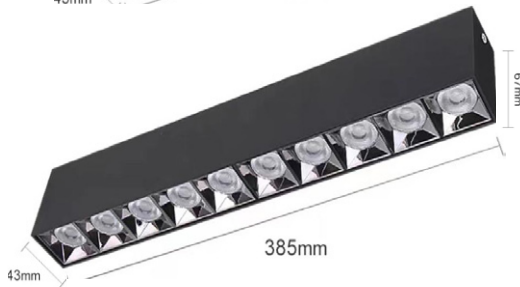
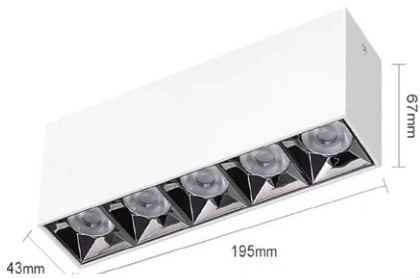


Jupiter Mini 4367 Surface Mounted LED Downlight



Features

- Cut-off angle 55°
- Available in 3 sizes for different areas
- CRI>80/90 Colour Tolerance<3 SCDM
- Strobo-less driver
- Applications: Hotels,villas,clubs,opera houses, museums,exhibition centers,stores,home etc.



Dimensions

Wattage	3*2W 5*4W 10*4W
Product Dimensions (mm)	120*43*67 (LxWxH) 195*43*67 (LxWxH) 385*43*67 (LxWxH)
LED	Osram/Cree
Input Voltage	AC 220V-240V
Input Current/Vf	150mA/36V 500mA/36V 1000mA/36V
CCT	2700K/3000K/4000K/5000K
CRI	80/90
Beam Angle	15°/24°/38°
Lumen	240lm / 800lm / 1600lm
Driver	Australia Certified Driver
PF	>0.8
Dimming	Traic/0-10V/Dali
Output Voltage	DC 36V
Housing Colours	Black / White / Silver
Material	Aluminum with surface powder coating

Certification and Safety

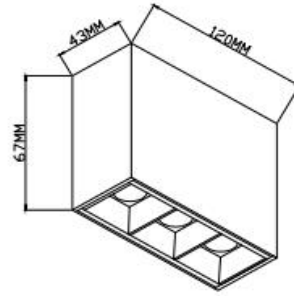
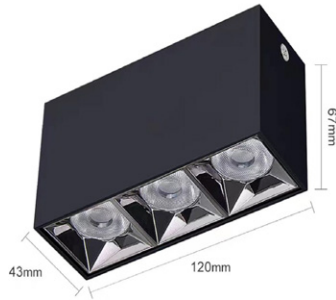
Certificate	CE, ROHS, RCM, SAA
IP Rating	IP20
Warranty	3 Years for residential 5 Years for commercial

Jupiter Mini 4367 Surface Mounted LED Downlight

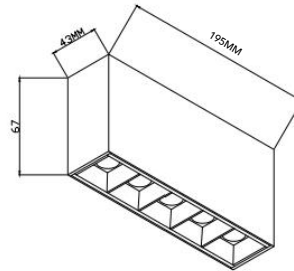
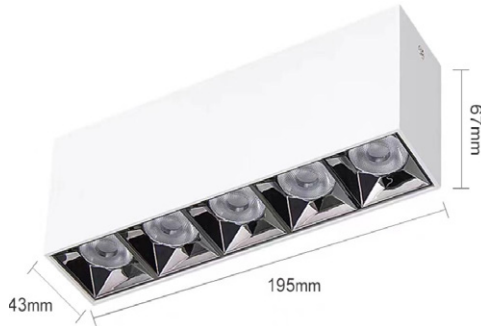


Diagram (mm)

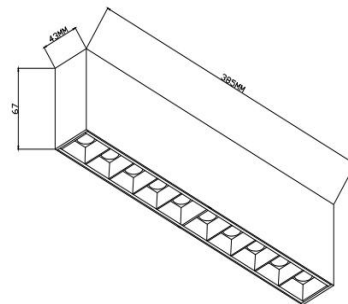
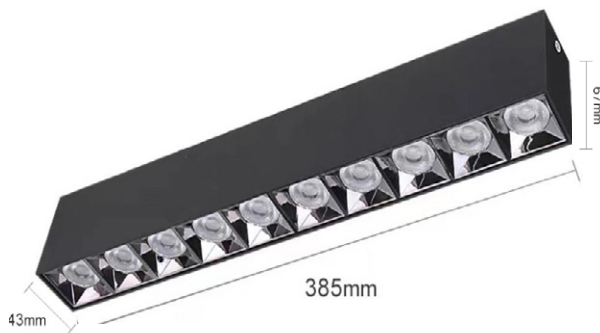
L120 * W43 * H67



L195 * W43 * H67



L385 * W43 * H67



Measurement

Model	Dimension(mm)			Lumen	CCT Colour	Dimming
	L	W	H			
GJJUP-6W-120-M4367	120	43	67	240lm	2700K/3000K/4000K/5000K	Traic/0-10V/Dali
GJJUP-20W-195-M4367	195	43	67	800lm		
GJJUP-40W-385-M4367	385	43	67	1600lm		