



Chain GLLS-L Series

LED Linear Light

3CCT Switchable

Emergency Backup

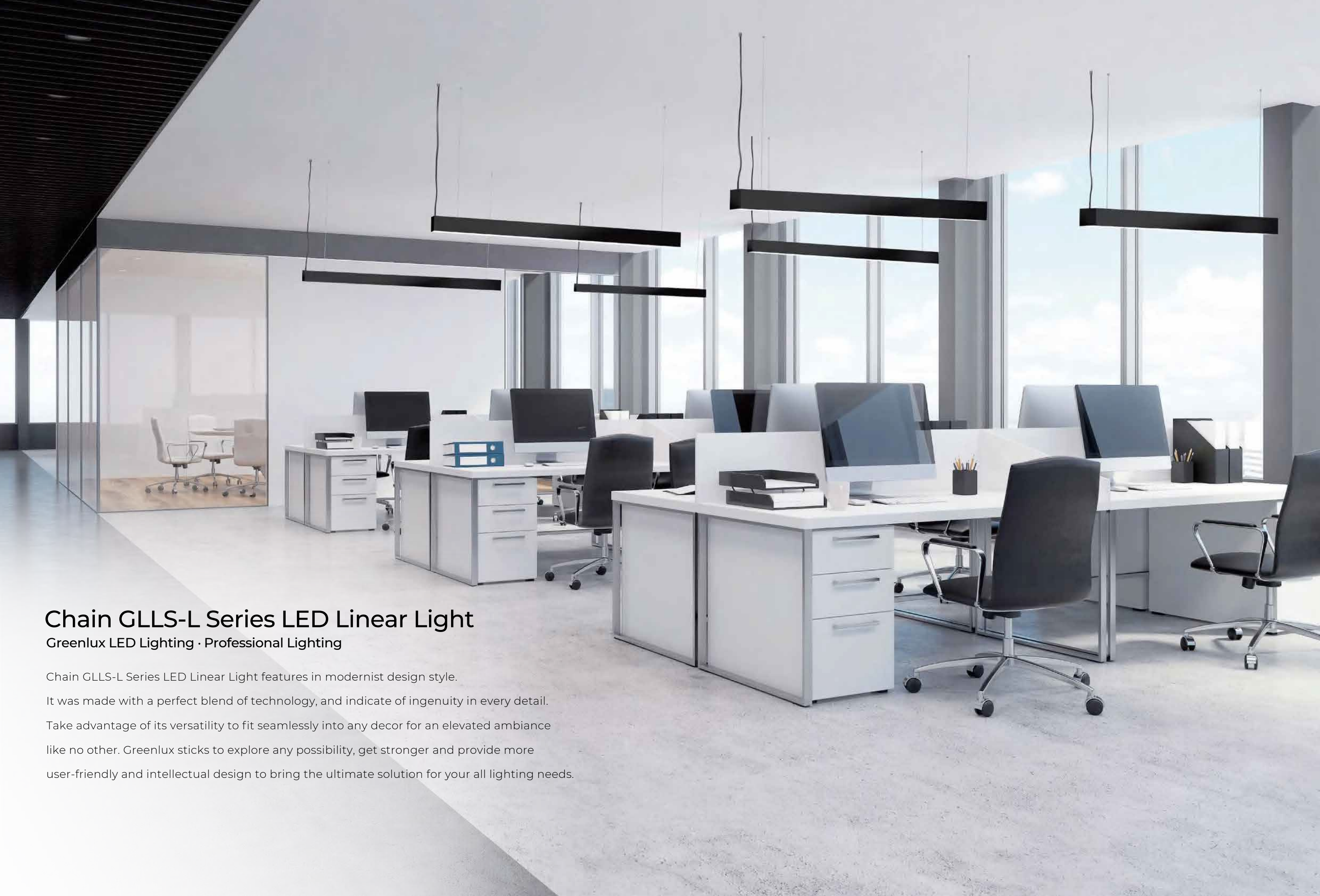

Chain GLLS-L Series LED Linear Light

Greenlux LED Lighting · Professional Lighting

Chain GLLS-L Series LED Linear Light features in modernist design style.

It was made with a perfect blend of technology, and indicate of ingenuity in every detail.

Take advantage of its versatility to fit seamlessly into any decor for an elevated ambiance

like no other. Greenlux sticks to explore any possibility, get stronger and provide more

user-friendly and intellectual design to bring the ultimate solution for your all lighting needs.

GBS Model

Pendant, Surface Mounted,
Trimless Recessed

GBE Model NEW

Edged Embedding

Downward Lighting

Downward light-emitting luminaires adopt flood lighting design, featured in uniform light emission. Flood lighting design is an ideal option for providing efficient lighting in public areas.

GBS3360 / GBS5470 / GBS7977



GBE5535 / GBE6935 / GBE9435

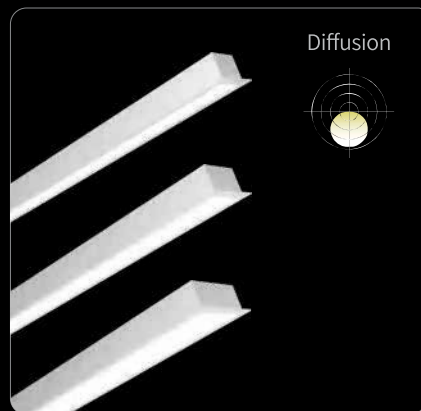

GBH Model

Pendant

Upward and downward lighting

Upward and downward light-emitting luminaires can provide premium indirect lighting. Abundant downward light would provide excellent basic lighting; large upward light-emitting surface can brighten up ceiling to get more transparent and less depressing space.

GBH3360



GBH5470



GBH7977

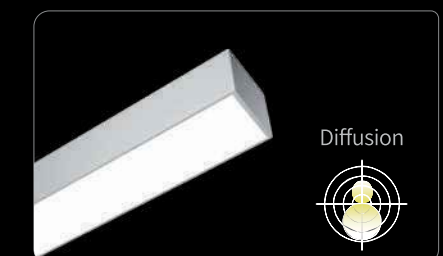

Practical Application Cases



Practical Application Cases

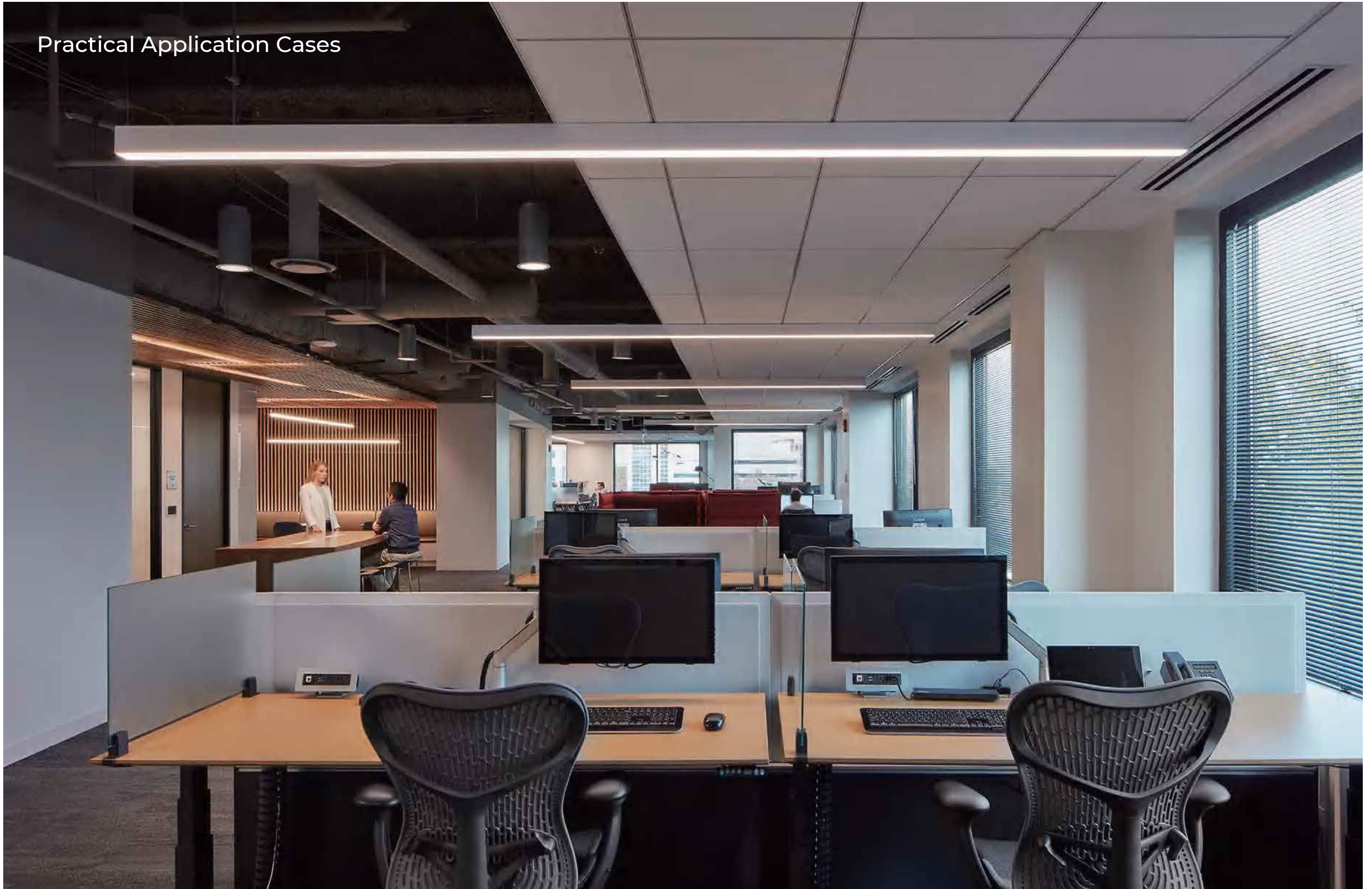

Practical Application Cases



Practical Application Cases

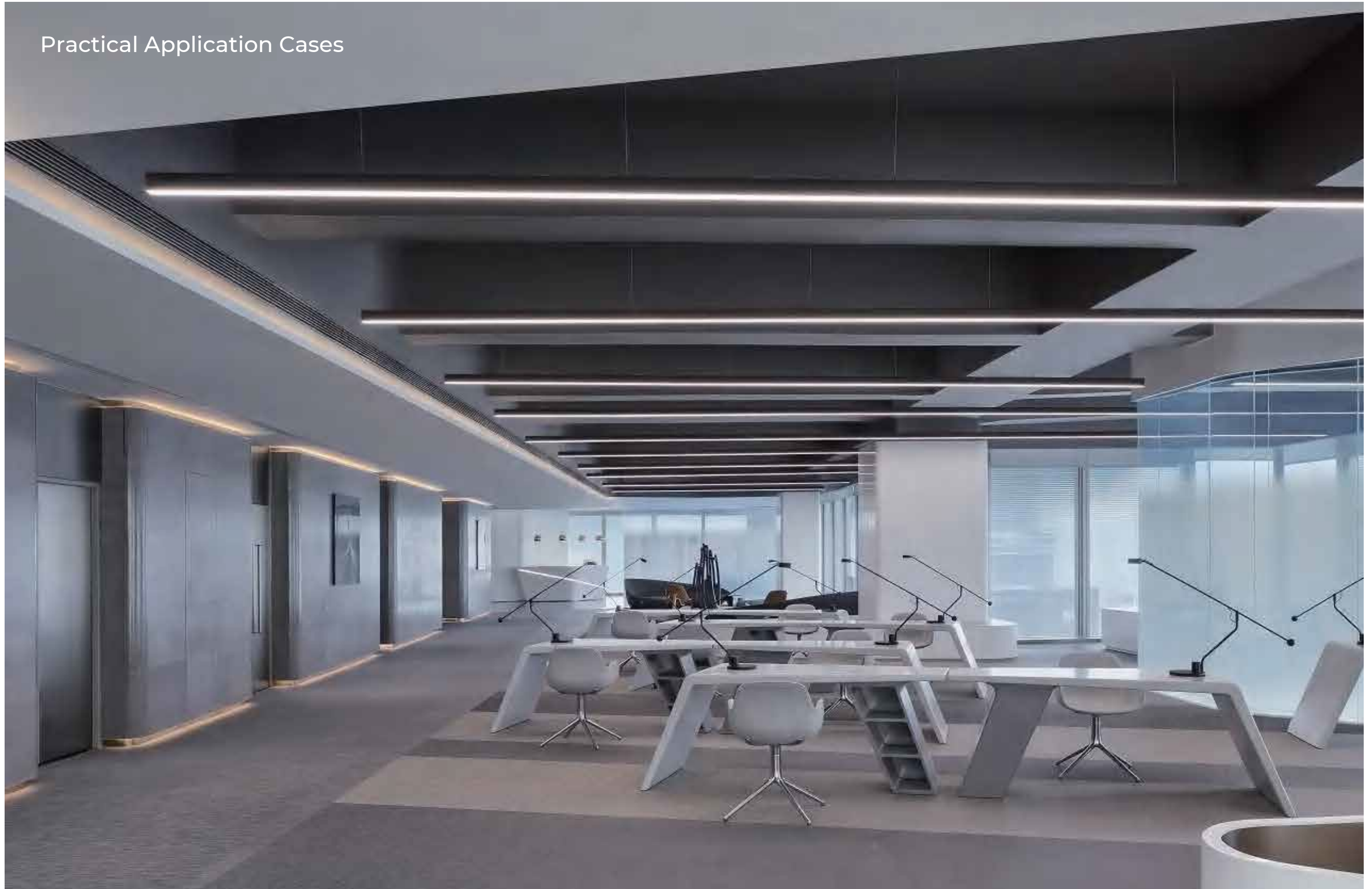



Ingenious Design · Supreme Experience

Satisfy needs for edged embedded, trimless recessed, pendant and ceiling installation. Its seamless design and easy installation make it an excellent choice for lighting up any room, emitting a soft yet powerful glow. The lamp is available in three colours, it creates ultimate light experience for you.

- 1** Meet various installation requirements
- 2** Whole luminaire splicing bars
- 3** All-wrapped leak-proof end cap
- 4** Three Colours Optional

1 Meet various installation requirements

Satisfy needs for edged embedded, trimless recessed, pendant and ceiling installation.

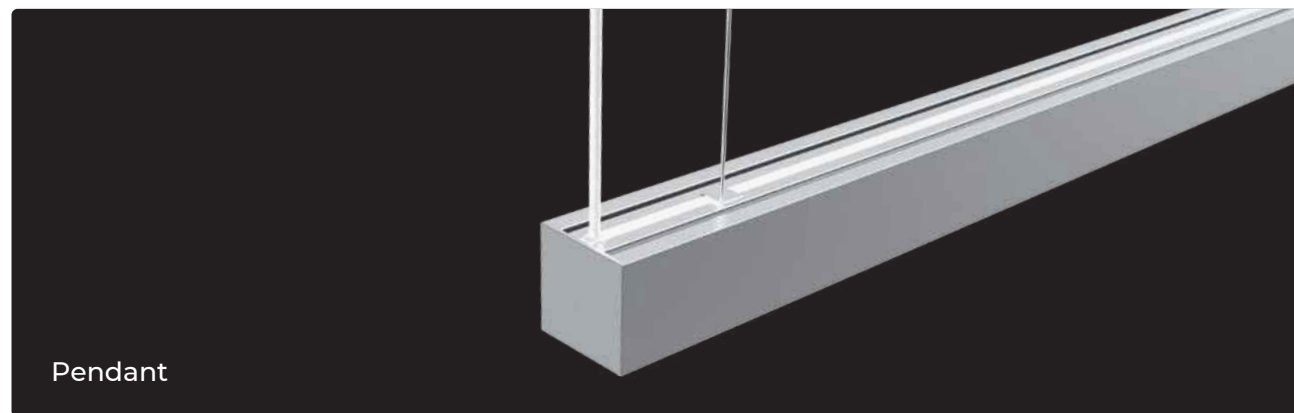
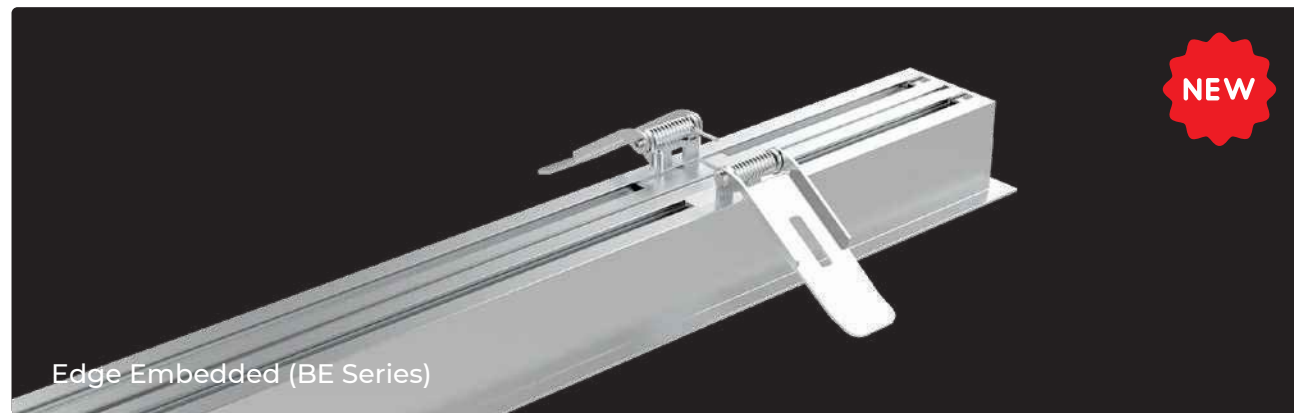
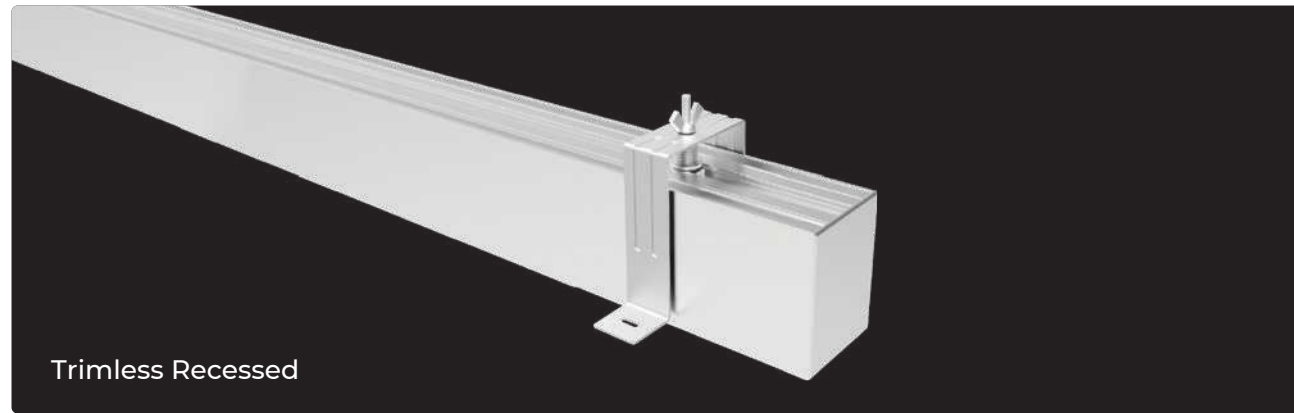
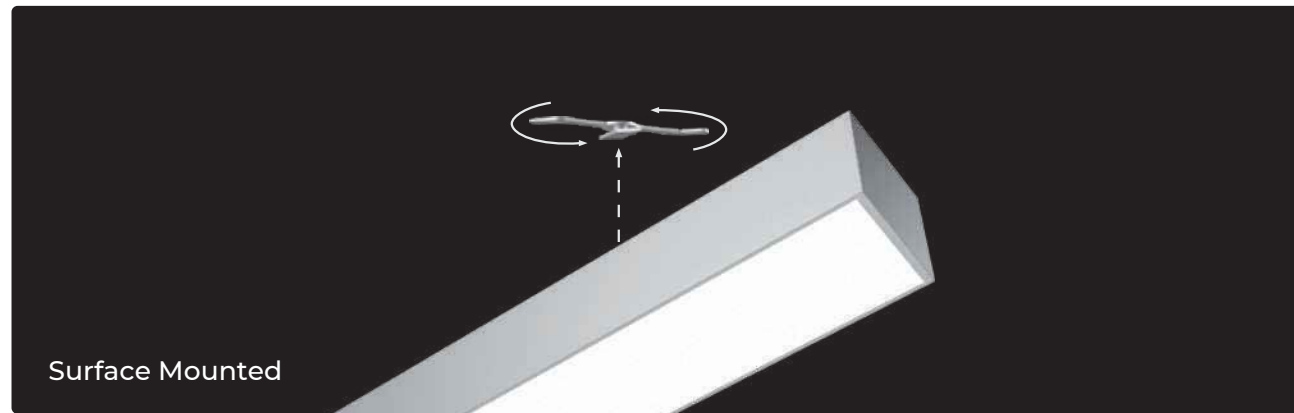



2

Whole luminaire splicing bars

- Splice without needs for detaching end caps
- Efficient and convenient



3

All-wrapped light leak-proof end cap

- Innovative light leak-proof design adopted;
- Detachable diffuser assures of easier maintenance;
- End cap has a shading edge to prevent light leakage from the diffuser;
- Innovative snap-on end cap adopted for easy operation.

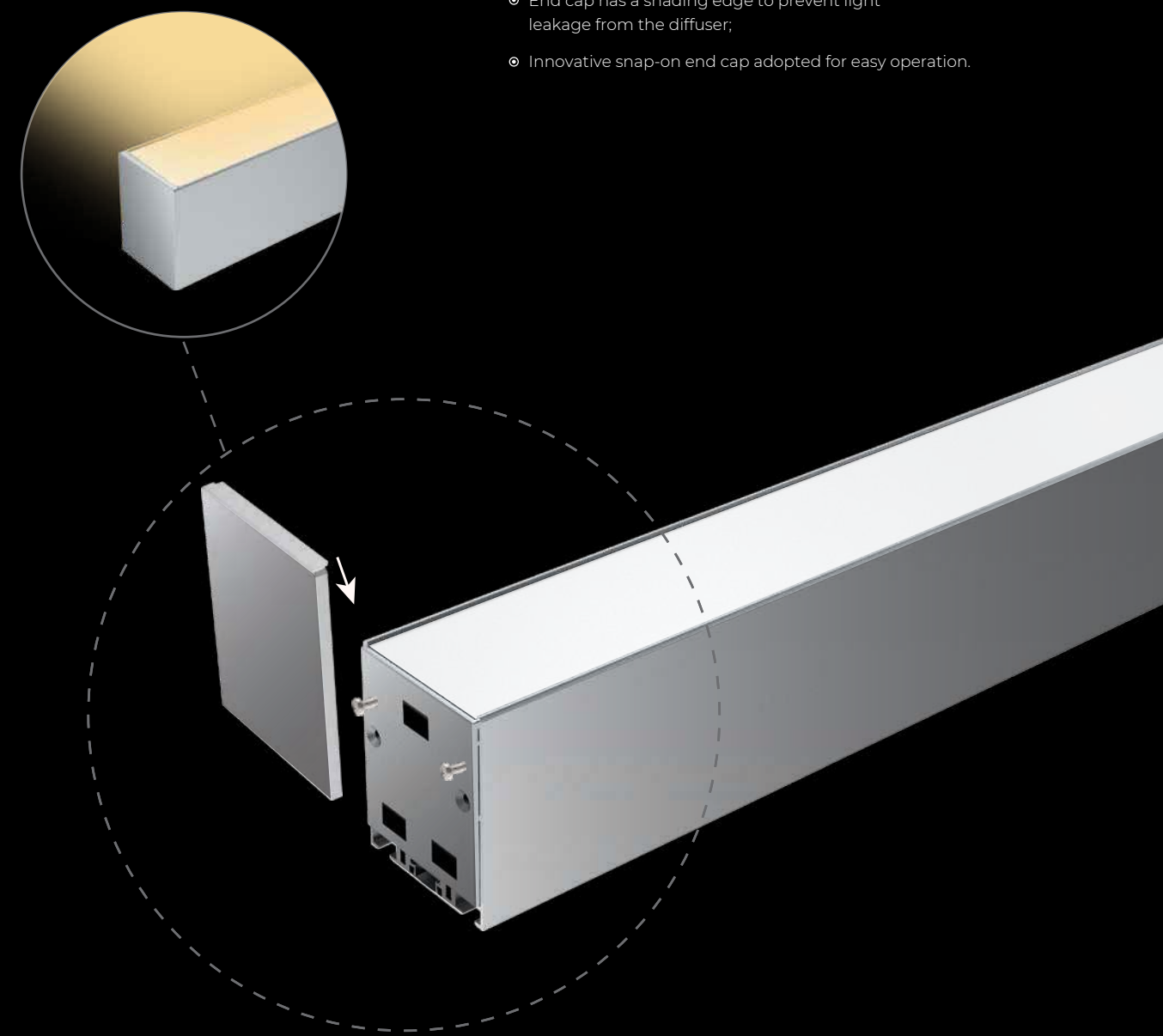

4 Three Colours Optional

Black, white and silver optional, supports colour customisation

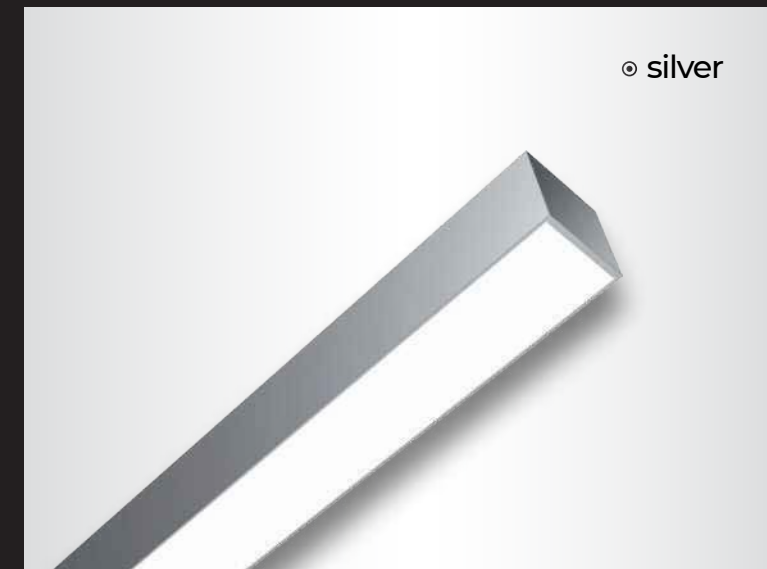

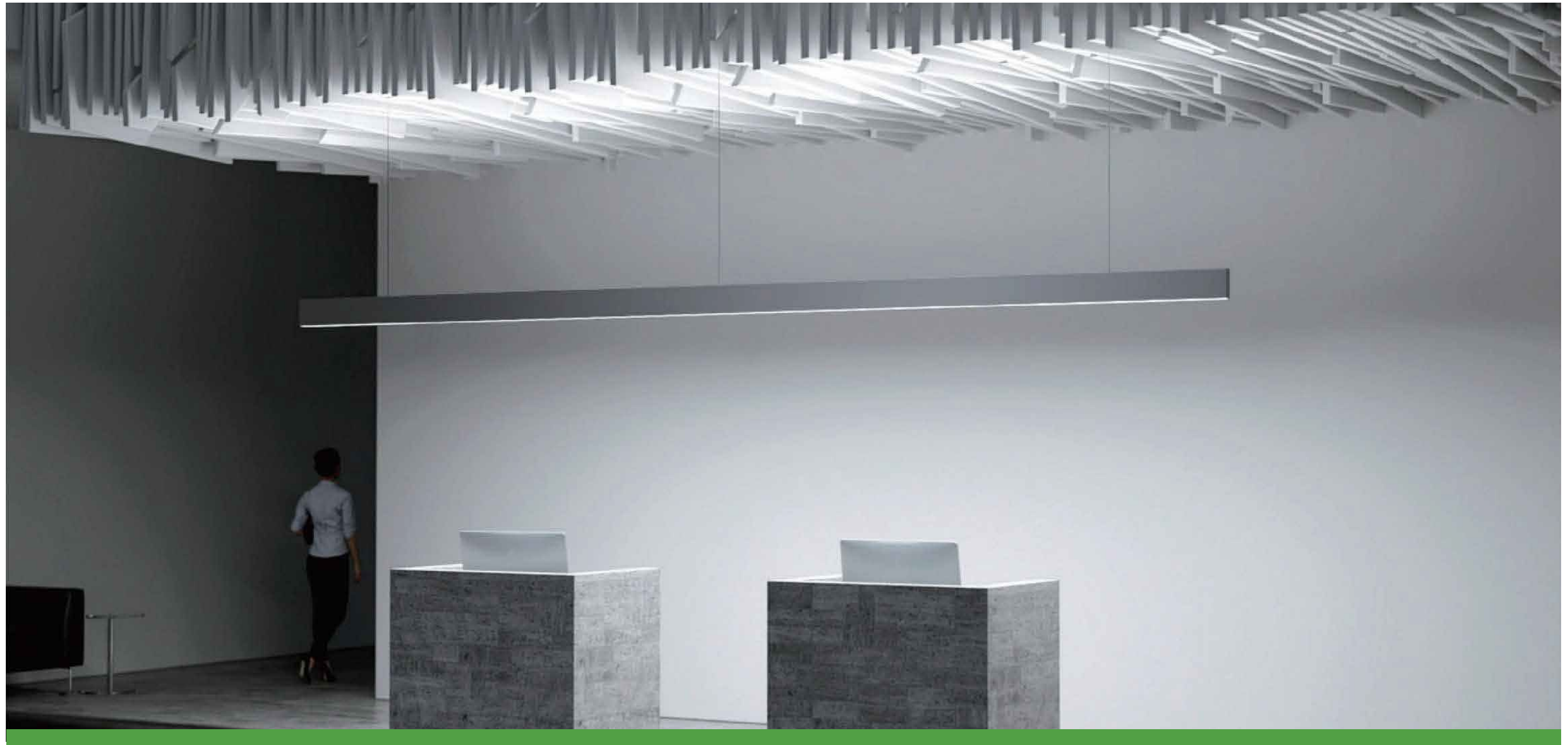

Superb performance · Superb quality

The linear light is designed to provide optimal lighting with its various and customisable CCT options, making it a smart choice for a range of lighting needs. This energy-efficient light boasts stable light efficiency with three dimming modes for free dimming and a dial switch for adjusting CCT at will. Plus, it's equipped with an emergency power supply for 3-hour lighting during a power outage. Our handpicked, qualified lamp beans ensure the highest quality, creating maximum benefits for you.

- 1** Multiple CCT optional
- 2** Energy-efficient
- 3** Three light-tuning modes
- 4** Dial switch for CCT adjustment
- 5** Built-in emergency power supply
- 6** Handpicked Lamp Beans · Ingenious Production

1

Multiple CCT Optional

Supports CCT
Customisation

2700K

3000K

4000K

5000K

6500K

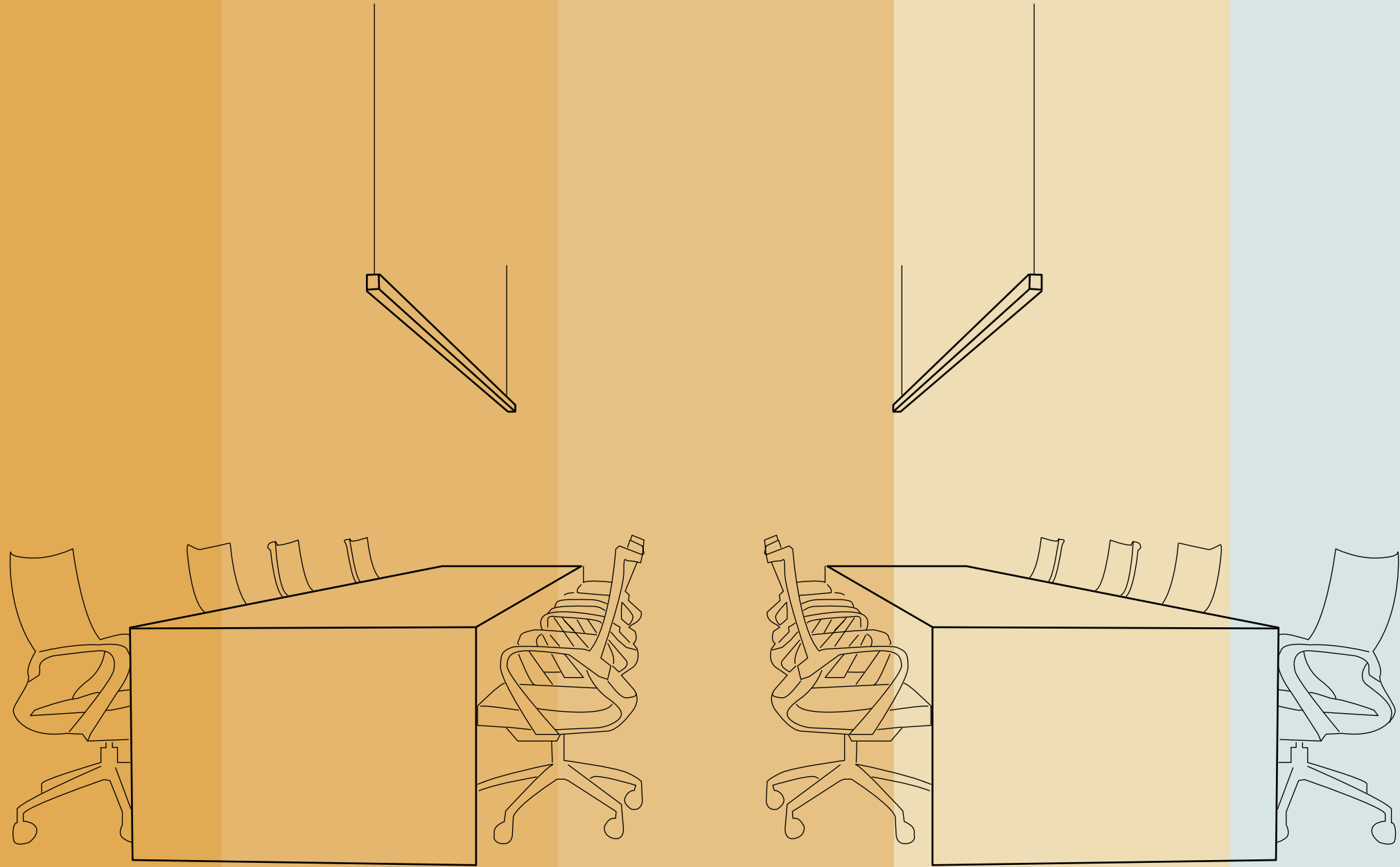



2

Energy-efficient

High luminance, high light efficiency

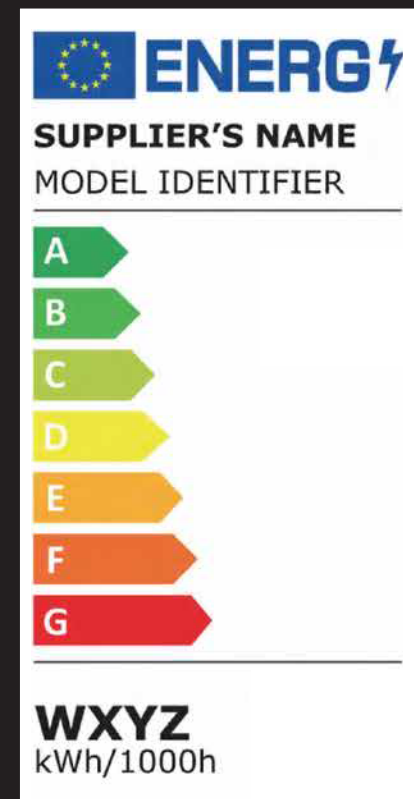

▲
110LM/W

D-level in ERP energy efficiency rating

3

Three Light-tuning Modes

- Outfitted with slim and high-quality power supply;
- Perfectly built in linear luminaire, achieves free light tuning.



NO DIMMING

Supports no dimming

1-10V

1-10V Dimming



DALI dimming



100%

75%

50%

25%



4 Dial switch for CCT adjustment

Outfitted with dial switch for flexible three-gears dimming

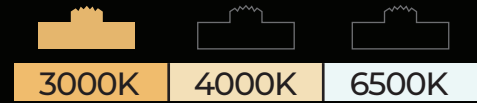
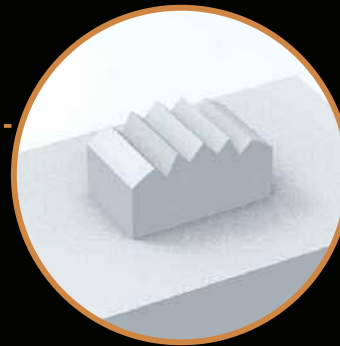

3000K

Warm light · Warm atmosphere

4000K

Neutral light · Soft and natural

6000K

White light · Bright and comfortable



NEW



5

Built-in emergency power
Emergency lighting for
3 hours in case of power outage



- ◉ When power supply is working, indicating light is off
- ◉ When power supply is charging, indicating light is green
- ◉ Red button, one-click detection



NEW



130 LM/W

6

Handpicked Lamp Beans Ingenious Production

- Handpicked global-brand BRIDGELUX lamp beans
- Qualified for authoritative certifications inclusive of LM80, CE, CB, RCM. Five-year warranty.

High-efficiency Model

1 BIN ONLY

3 SDCM \leq 3

Same Forever

BRIDGELUX Light Source

CRI > 80 CRI > 90

LM-80

5 years

CE CB

GBS Model Downward Lighting

Pendant, surface mounted,
trimless recessed

GBS3360

- AL6063-T5 aluminum profile with high-quality surface treatment
- Three optional colours of black/white/silver.
- LM80 certified light source, bridgelux LED, life >50000H
- Built-in efficient and safe flicker-free dimming power supply, Support 1-10V dimming or Dali dimming

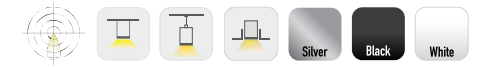

Support customisation of Ra90 light source.

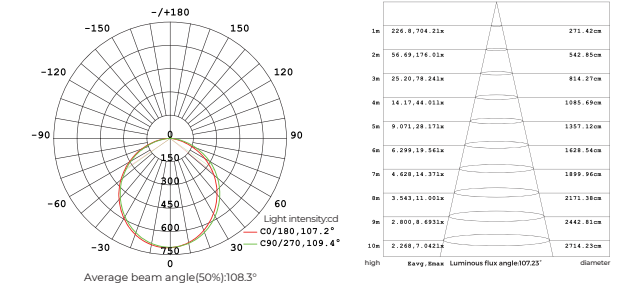
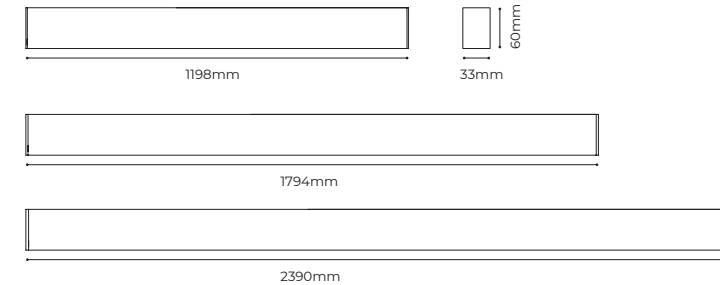

Luminaire Parameter			
Diameter	1198*33*60mm	1794*33*60mm	2390*33*60mm
Diffuser Type	Diffuser		
Diffuser Material	PC		
Luminous Flux	1900LM	2700LM	4000LM
Luminous flux (high luminous effect)	2370LM	3370LM	4750LM
Power	19W	27W	38W
Color Temperature	2700K/3000K/3500K/4000K/5000K/6500K		
CRI	>80, >90		
Light-emitting Angle	110°		
Input Voltage	200-240VAC 50Hz/60Hz		
Power Factor	>0.9		
Power Supply	Built-in isolated power		
Light-tuning Method	Non-dimming/1-10V/DALI/CCT dial switch		
Colour	Silver <input type="radio"/> White <input type="radio"/> Black <input type="radio"/>		
Installation Method	Pendant, surface mounted, trimless recessed		
Warranty	5 years		
Certification	CE		

Installation Accessories

Pendant Component (with ceiling box)	PY-DXXX 2m/4m	
Pendant Component (without ceiling box)	PN-DXX 2m/4m	
Ceiling screw	CL-01 M3.5 x 40mm	
Boom	PG-IA2	
Whole luminaire splicing bars	EX-41-S 120X23X19mm	

Ordering Code

Model Number	Installation	Section Size	Diffuser Shape	Diffuser Nature	Carrier Style	Profile Colour	End Cap Style	Length	Version	Light Source Type	Light Source Power	CCT	CRI	Power Type
CCCHA-GLLS-GBS3360-19W-1200	Pendant	BS 30 Series	Flat	F Diffuse D	Flat F	Silver S	Standard end cap	1200mm	-	Constant Current Rigid	19W 19	2700K SW	>80 8	1-10V dimming B
CCCHA-GLLS-GBS3360-27W-1800		3360				White W		1800mm	High efficiency (H)		27W 27	3000K WW	>90 9	DALI dimming A
CCCHA-GLLS-GBS3360-38W-2400						Black B		2400mm	Emergency power (E)		38W 38	3500K PW		No dimming N
												4000K NW		
												5000K DW		
												6500K W		
												3000K-6500K WWW		
GLLS	-	BS 3360	F	D	F	W	S	1200	-	T	19	NW	8	B

GBS5470

- AL6063-T5 aluminum profile with high-quality surface treatment
- Three optional colours of black/white/silver.
- LM80 certified light source, bridgelux LED, life >50000H
- Built-in efficient and safe flicker-free dimming power supply, Support 1-10V dimming or Dali dimming

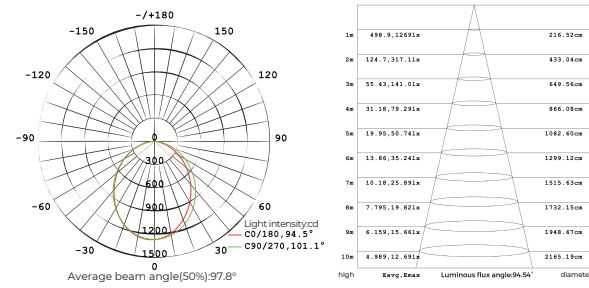
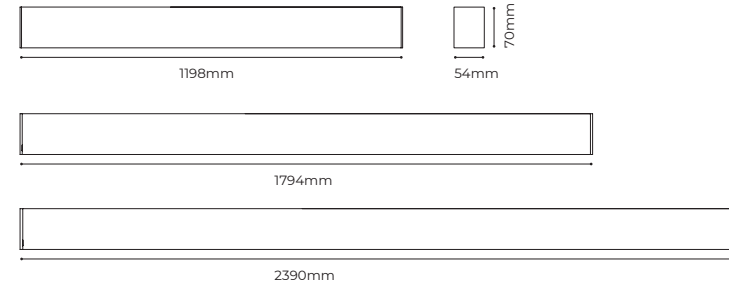

Luminaire Parameter			
Diameter	1198*54*70mm	1794*54*70mm	2390*54*70mm
Diffuser Type	Diffuser		
Diffuser Material	PC		
Luminous Flux	2970LM	4180LM	5830LM
Luminous flux (high luminous effect)	3510LM	4940LM	6890LM
Power	27W	38W	53W
Color Temperature	2700K/3000K/3500K/4000K/5000K/6500K		
CRI	>80, >90		
Light-emitting Angle	110°		
Input Voltage	200-240VAC 50Hz/60Hz		
Power Factor	>0.9		
Power Supply	Built-in isolated power		
Light-tuning Method	Non-dimming/1-10V/DALI/CCT dial switch		
Colour	Silver <input type="radio"/> White <input type="radio"/> Black <input type="radio"/>		
Installation Method	Pendant, surface mounted, trimless recessed		
Warranty	5 years		
Certification	CE		

Installation Accessories	
Pendant Component (with ceiling box)	PY-DXXX 2m/4m
Pendant Component (without ceiling box)	PN-DXX 2m/4m
Boundless embedded accessories	RE-03 110X25X82mm
Ceiling accessories	CL-06 90.5X54X5.9mm
Boom	PG-IA2
Whole luminaire splicing bars	EX-41-S 120X23X19mm

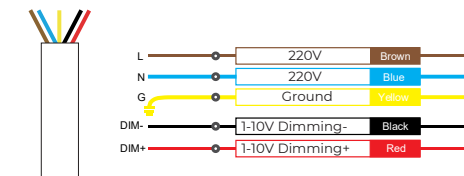

Model Code

Model Number	Installation	Section Size	Diffuser Shape	Diffuser Nature	Carrier Style	Profile Colour	End Cap Style	Length	Version	Light Source Type	Light Source Power	CCT	CRI	Power Type						
CCCHA-GLLS-GBS5470-27W-1200	Pendant	BS 50 Series	Flat	F	Diffuse D	Flat	F	Silver S	Standar end cap	S	1200mm	/	-	Constant Current Rigid	T	27W 27	2700K SW	>80 8	1-10V dimming	B
CCCHA-GLLS-GBS5470-38W-1800		5470				White W		1800mm	High efficiency (H)		38W 38	3000K WW	>90 9	DALI dimming	A					
CCCHA-GLLS-GBS5470-53W-2400						Black B		2400mm	Emergency power (E)		53W 53	3500K PW		No dimming	N					
												4000K NW								
												5000K DW								
												6500K W								
												3000K-6500K	WWW							
GLLS	-	BS 5470	F	D	F	W	S	1200	-	T	27	NW	8	B						

GBS7977

- AL6063-T5 aluminum profile with high-quality surface treatment
- Three optional colours of black/white/silver.
- LM80 certified light source, bridgelux LED, life >50000H
- Built-in efficient and safe flicker-free dimming power supply, Support 1-10V dimming or Dali dimming

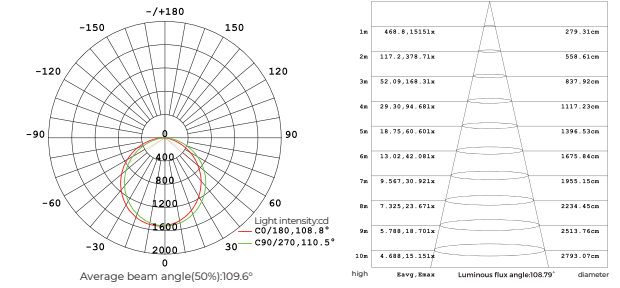
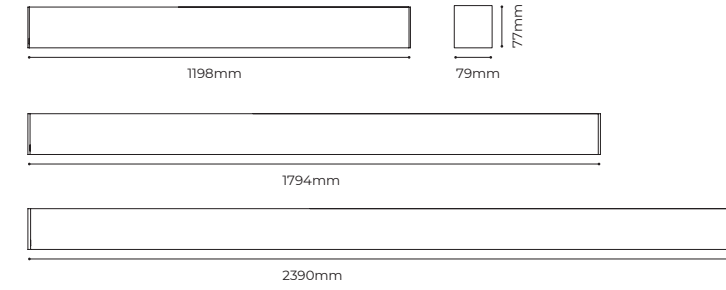

Luminaire Parameter			
Diameter	1198*79*77mm	1794*79*77mm	2390*79*77mm
Diffuser Type	Diffuser		
Diffuser Material	PC		
Luminous Flux	4250LM	6710LM	8390LM
Luminous flux (high luminous effect)	4940LM	7800LM	9750LM
Power	38W	60W	75W
Color Temperature	2700K/3000K/3500K/4000K/5000K/6500K		
CRI	>80, >90		
Light-emitting Angle	110°		
Input Voltage	200-240VAC 50Hz/60Hz		
Power Factor	>0.9		
Power Supply	Built-in isolated power		
Light-tuning Method	Non-dimming/1-10V/DALI/CCT dial switch		
Colour	Silver <input type="radio"/> White <input type="radio"/> Black <input type="radio"/>		
Installation Method	Pendant, surface mounted, trimless recessed		
Warranty	5 years		
Certification	CE		

Installation Accessories	
Pendant Component (with ceiling box)	PY-LXXX 2m/4m
Pendant Component (without ceiling box)	PN-LXX 2m/4m
Boundless embedded accessories	RE-04 135.4X25X90mm
Ceiling accessories	CL-09 126X54X5.9mm
Boom	PG-IA2
Whole luminaire splicing bars	EX-41-S 120X23X19mm

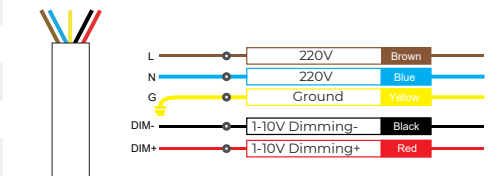

Model Code

Model Number	Installation	Section Size	Diffuser Shape	Diffuser Nature	Carrier Style	Profile Colour	End Cap Style	Length	Version	Light Source Type	Light Source Power	CCT	CRI	Power Type						
CCCHA-GLLS-GBS7977-38W-1200	Pendant	BS 70 Series	Flat	F	Diffuse D	Flat	F	Silver S	Standar end cap	S	1200mm	/	-	Constant Current Rigid	T	38W 38	2700K SW	>80 8	1-10V dimming	B
CCCHA-GLLS-GBS7977-60W-1800		7977				White W		1800mm	High efficiency (H)		60W 60	3000K WW	>90 9	DALI dimming	A					
CCCHA-GLLS-GBS7977-75W-2400						Black B		2400mm	Emergency power (E)		75W 75	3500K PW		No dimming	N					
												4000K NW								
												5000K DW								
												6500K W								
												3000K-6500K	WWW							
GLLS	-	BS 7977	F	D	F	W	S	1200	-	T	38	NW	8	B						

GBH3360



- AL6063-T5 aluminum profile with high-quality surface treatment
- Three optional colours of black/white/silver.
- LM80 certified light source, bridgelux LED, life >50000H
- Built-in efficient and safe flicker-free dimming power supply, Support 1-10V dimming or Dali dimming
- Upward and down lighting

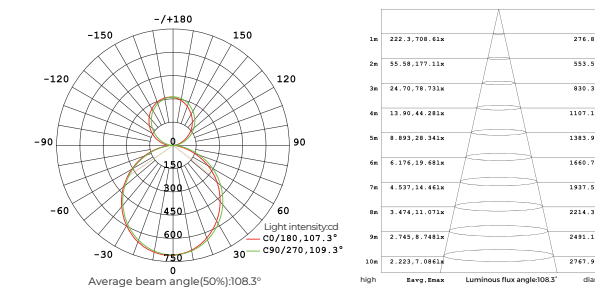
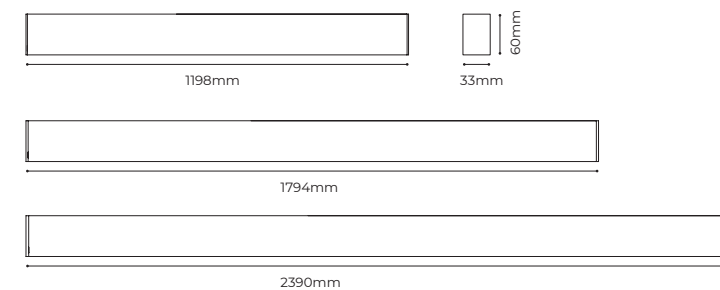

Luminaire Parameter				Installation Accessories	
Diameter	1198*33*60mm	1794*33*60mm	2390*33*60mm	Pendant Component (with ceiling box)	PY-DXXX 2m/4m
Diffuser Type	Diffuser			Pendant Component (without ceiling box)	PN-DXX 2m/4m
Diffuser Material	PC			Lifting clip	CP-13
Luminous Flux	900lm(up) 800lm(down)	1500lm(up) 3000lm(down)	2000lm(up) 4000lm(down)	Whole luminaire splicing bars	EX-41-S 120X23X19mm
Luminous flux (high luminous effect)	1120lm(up) 2240lm(down)	1870lm(up) 3735lm(down)	2490lm(up) 4980lm(down)		
Power	9W (up) 18W(down)	15W (up) 30W(down)	20W (up) 40W(down)		
Color Temperature	2700K/3000K/3500K/4000K/5000K/6500K				
CRI	>80, >90				
Light-emitting Angle	110°				
Input Voltage	200-240VAC 50Hz/60Hz				
Power Factor	>0.9				
Power Supply	Built-in isolated power				
Light-tuning Method	Non-dimming/1-10V/DALI/CCT dial switch				
Colour	Silver <input type="radio"/> White <input type="radio"/> Black <input type="radio"/>				
Installation Method	Pendant				
Warranty	5 years				
Certification	CE				

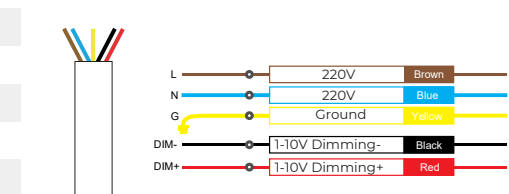

Model Number	Installation	Section Size	Diffuser Shape	Diffuser Nature	Carrier Style	Profile Colour	End Cap Style	Length	Version	Light Source Type	Light Source Power	CCT	CRI	Power Type
CCCHA-GLLS-GBH3360-27W-1200	Pendant	BH 30 Series	Flat	F	Diffuse D	Flat F	Silver S	Standar end cap S	1200mm /	Constant Current Rigid	27W 27	2700K SW	>80 8	1-10V dimming B
CCCHA-GLLS-GBH3360-45W-1800		3360				White W		1800mm	High efficiency (H)		45W 45	3000K WW	>90 9	DALI dimming A
CCCHA-GLLS-GBH3360-60W-2400						Black B		2400mm	Emergency power (E)		60W 60	3500K PW		No dimming N
												4000K NW		
												5000K DW		
												6500K W		
												3000K-6500K WWW		
GLLS		BH 3360	F	D	F	W	S	1200		T	27	NW	8	B

GBH Model Up / down lighting

Pendant

GBH5470

- AL6063-T5 aluminum profile with high-quality surface treatment
- Three optional colours of black/white/silver.
- LM80 certified light source, bridgelux LED, life >50000H
- Built-in efficient and safe flicker-free dimming power supply, Support 1-10V dimming or Dali dimming
- Upward and down lighting

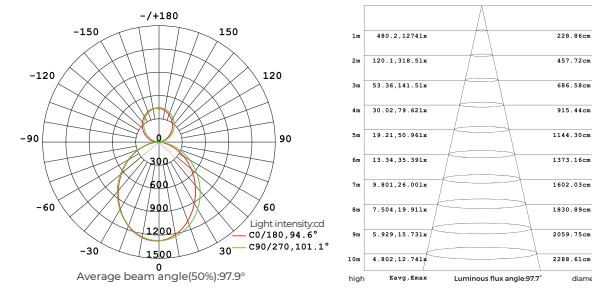
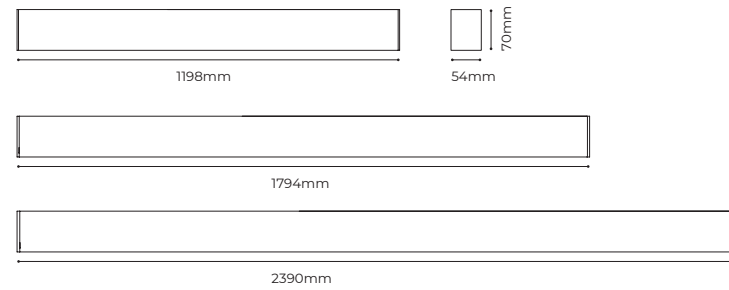
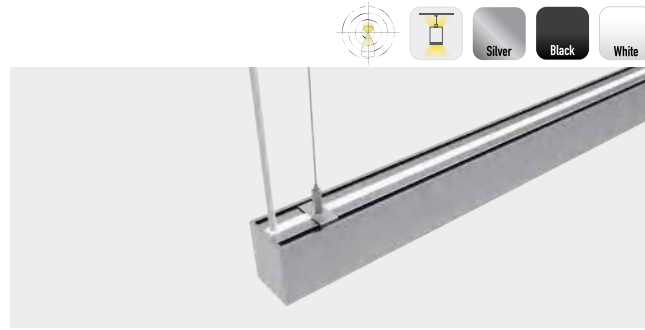

Luminaire Parameter			
Diameter	1198*54*70mm	1794*54*70mm	2390*54*70mm
Diffuser Type	Diffuser		
Diffuser Material	PC		
Luminous Flux	1430lm(up)2750lm(down)	2200lm(up)4400lm(down)	2750lm(up)5500lm(down)
Luminous flux (high luminous effect)	1690lm(up)3250lm(down)	2600lm(up)5200lm(down)	3250lm(up)6500lm(down)
Power	13W (up) 25W(down)	20W (up) 40W(down)	25W (up) 50W(down)
Color Temperature	2700K/3000K/3500K/4000K/5000K/6500K		
CRI	>80, >90		
Light-emitting Angle	110°		
Input Voltage	200-240VAC 50Hz/60Hz		
Power Factor	>0.9		
Power Supply	Built-in isolated power		
Light-tuning Method	Non-dimming/1-10V/DALI/CCT dial switch		
Colour	Silver <input type="radio"/> White <input type="radio"/> Black <input type="radio"/>		
Installation Method	Pendant		
Warranty	5 years		
Certification	CE		

Installation Accessories	
Pendant Component (with ceiling box)	PY-DXXX 2m/4m
Pendant Component (without ceiling box)	PN-DXX 2m/4m
Lifting clip	CP-16
Whole luminaire splicing bars	EX-4]-S 120X23X19mm

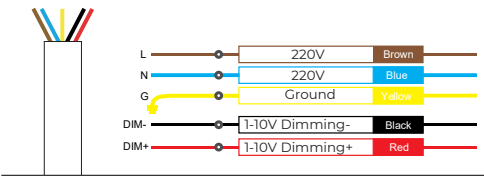

Model Code

Model Number	Installation	Section Size	Diffuser Shape	Diffuser Nature	Carrier Style	Profile Colour	End Cap Style	Length	Version	Light Source Type	Light Source Power	CCT	CRI	Power Type								
CCCHA-GLLS-GBH5470-38W-1200	Pendant	BH 50 Series	Flat	F	Diffuse D	Flat	F	Silver S	Standar end cap	S	1200mm	/	-	Constant Current Rigid	T	38W 38	2700K	SW	>80	8	1-10V dimming	B
CCCHA-GLLS-GBH5470-60W-1800		5470						White W			1800mm			High efficiency (H)		60W 60	3000K	WW	>90	9	DALI dimming	A
CCCHA-GLLS-GBH5470-75W-2400								Black B			2400mm			Emergency power (E)		75W 75	3500K	PW			No dimming	N
																	4000K	NW				
																	5000K	DW				
																	6500K	W				
																	3000K-6500K	WWW				
GLLS	-	BH 5470	F	D	F	W	S	1200	-	T	38	NW	8	B								

GBH7977

- AL6063-T5 aluminum profile with high-quality surface treatment
- Three optional colours of black/white/silver.
- LM80 certified light source, bridgelux LED, life >50000H
- Built-in efficient and safe flicker-free dimming power supply, Support 1-10V dimming or Dali dimming
- Upward and down lighting

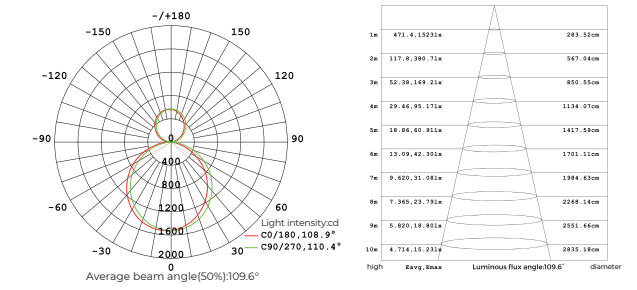
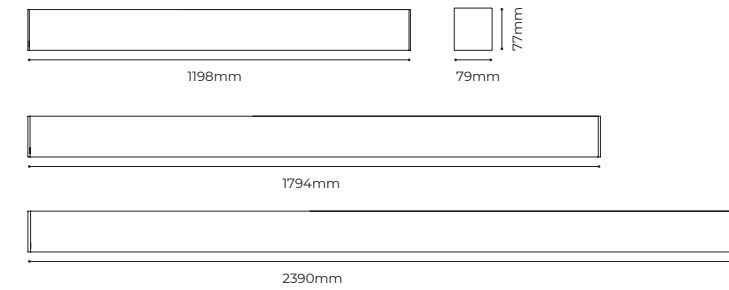

Luminaire Parameter			
Diameter	1198*79*77mm	1794*79*77mm	2390*79*77mm
Diffuser Type	Diffuser		
Diffuser Material	PC		
Luminous Flux	1455lm(up)4475lm(down)	2125lm(up)6265lm(down)	2910lm(up)8505lm(down)
Luminous flux (high luminous effect)	1690lm(up)5200lm(down)	2470lm(up)7280lm(down)	3380lm(up)9880lm(down)
Power	13W (up) 40W(down)	19W (up) 56W(down)	26W (up) 76W(down)
Color Temperature	2700K/3000K/3500K/4000K/5000K/6500K		
CRI	>80, >90		
Light-emitting Angle	110°		
Input Voltage	200-240VAC 50Hz/60Hz		
Power Factor	>0.9		
Power Supply	Built-in isolated power		
Light-tuning Method	Non-dimming/1-10V/DALI/CCT dial switch		
Colour	Silver <input type="radio"/> White <input type="radio"/> Black <input type="radio"/>		
Installation Method	Pendant		
Warranty	5 years		
Certification	CE		

Installation Accessories	
Pendant Component (with ceiling box)	PY-DXXX 2m/4m
Pendant Component (without ceiling box)	PN-DXX 2m/4m
Lifting clip	CP-16
Whole luminaire splicing bars	EX-4]-S 120X23X19mm

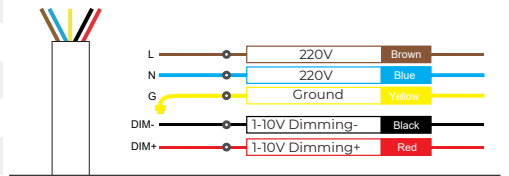

Model Code

Model Number	Installation	Section Size	Diffuser Shape	Diffuser Nature	Carrier Style	Profile Colour	End Cap Style	Length	Version	Light Source Type	Light Source Power	CCT	CRI	Power Type								
CCCHA-GLLS-GBH7977-53W-1200	Pendant	BH 70 Series	Flat	F	Diffuse D	Flat	F	Silver S	Standar end cap	S	1200mm	/	-	Constant Current Rigid	T	53W 53	2700K	SW	>80	8	1-10V dimming	B
CCCHA-GLLS-GBH7977-75W-1800		7977						White W			1800mm			High efficiency (H)		75W 75	3000K	WW	>90	9	DALI dimming	A
CCCHA-GLLS-GBH7977-102W-2400								Black B			2400mm			Emergency power (E)		102W 102	3500K	PW			No dimming	N
																	4000K	NW				
																	5000K	DW				
																	6500K	W				
																	3000K-6500K	WWW				
GLLS	-	BH 7977	F	D	F	W	S	1200	-	T	53	NW	8	B								

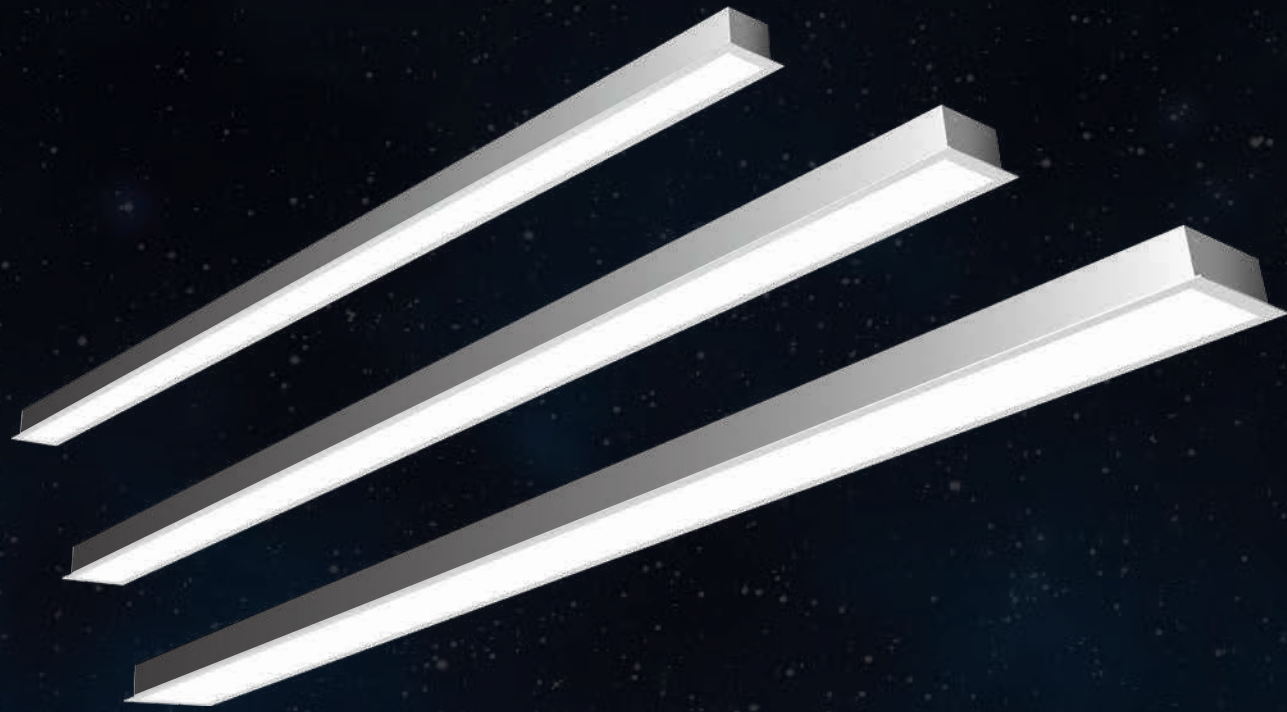

GBE5535 NEW



- AL6063-T5 aluminum profile with high-quality surface treatment
- Three optional colours of black/white/silver.
- LM80 certified light source, bridgelux LED, life >50000H
- Built-in efficient and safe flicker-free dimming power supply, Support 1-10V dimming or Dali dimming

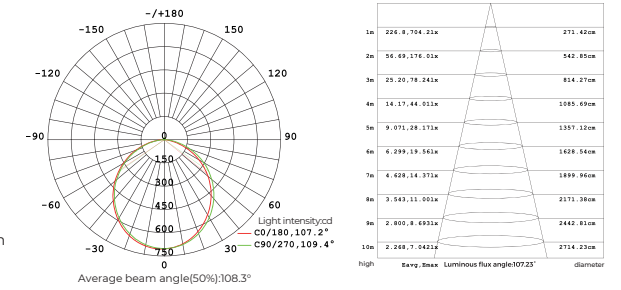
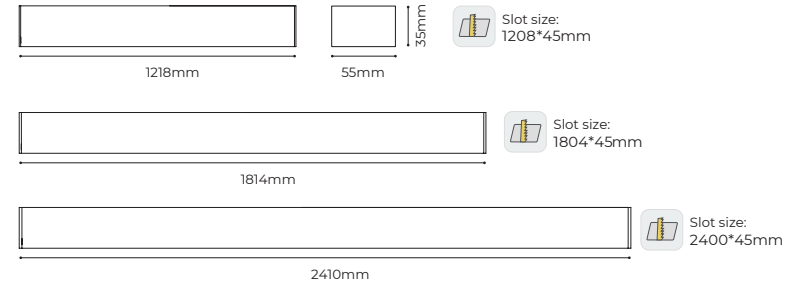
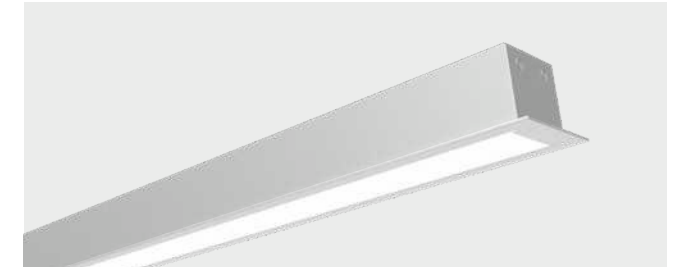

Luminaire Parameter			
Diameter	1198*55*35mm	1794*55*35mm	2500*55*35mm
Diffuser Type	Diffuser		
Diffuser Material	PC		
Luminous Flux	1900LM	2700LM	3800LM
Luminous flux (high luminous effect)	2370LM	3370LM	4740LM
Power	19W	27W	38W
Color Temperature	2700K/3000K/3500K/4000K/5000K/6500K		
CRI	>80, >90		
Light-emitting Angle	110°		
Input Voltage	200-240VAC 50Hz/60Hz		
Power Factor	>0.9		
Power Supply	Built-in isolated power		
Light-tuning Method	Non-dimming/1-10V/DALI/CCT dial switch		
Colour	Silver <input type="radio"/> White <input type="radio"/> Black <input type="radio"/>		
Installation Method	Edged Embedding		
Warranty	5 years		
Certification	CE		

Installation Accessories	
Recessed accessory	RB-02 L68.5xW35xH31.6mm
Accessory package	BG-02
Whole luminaire splicing bar	EX-17

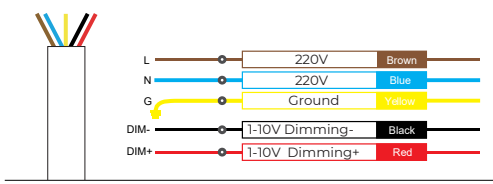

GBE Model Downward Lighting

Edged Embedding

Model Code

Model Number	Installation	Section Size	Diffuser Shape	Diffuser Nature	Carrier Style	Profile Colour	End Cap Style	Length	Version	Light Source Type	Light Source Power	CCT	CRI	Power Type	
GCCHA-GLLS-GBE5535-19W-1200	-	BE 55 Series	Flat	F	Diffuse D	Flat F	Silver S	Standar end cap	S	1200mm	19	2700K	SW	>80 B	1-10V dimming
GCCHA-GLLS-GBE5535-27W-1800		5535				White W		1800mm	High efficiency (H)	Constant Current Rigid	27W	3000K	WW	>90 9	DALI dimming
GCCHA-GLLS-GBE5535-38W-2400						Black B		2400mm	Emergency power (E)		38W	3500K	PW		No dimming
												4000K	NW		
												5000K	DW		
												6500K	W		
												3000K-6500K	WWW		
GLLS	-	BE 5535	F	D	F	S	S	1200	-	T	19	NW	B	B	

GBE6935 NEW



- AL6063-T5 aluminum profile with high-quality surface treatment
- Three optional colours of black/white/silver.
- LM80 certified light source, bridgelux LED, life >50000H
- Built-in efficient and safe flicker-free dimming power supply, Support 1-10V dimming or Dali dimming

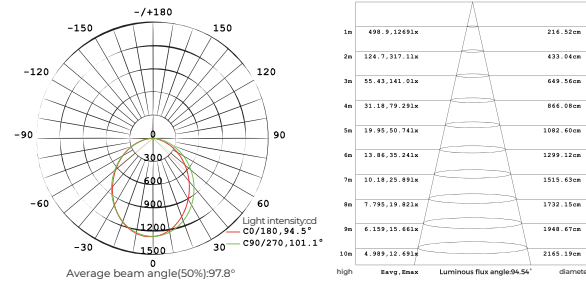
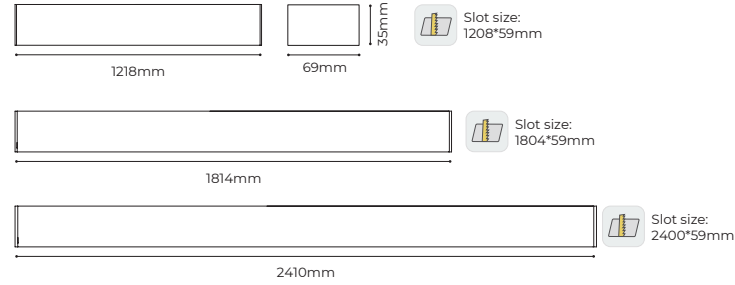
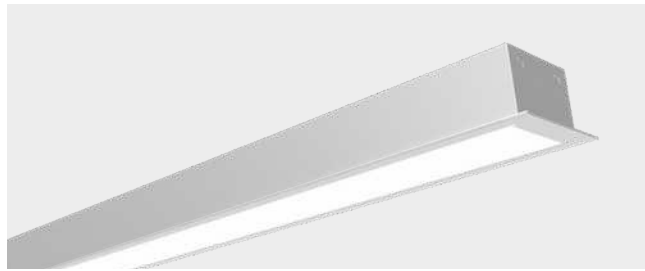

Luminaire Parameter		
Diameter	1198*69*35mm	1794*69*35mm
Diffuser Type	Diffuser	
Diffuser Material	PC	
Luminous Flux	2970LM	4180LM
Luminous flux (high luminous effect)	3510LM	4940LM
Power	27W	38W
Color Temperature	2700K/3000K/3500K/4000K/5000K/6500K	
CRI	>80, >90	
Light-emitting Angle	110°	
Input Voltage	200-240VAC 50Hz/60Hz	
Power Factor	>0.9	
Power Supply	Built-in isolated power	
Light-tuning Method	Non-dimming/1-10V/DALI/CCT dial switch	
Colour	Silver <input type="radio"/> White <input type="radio"/> Black <input type="radio"/>	
Installation Method	Edged Embedding	
Warranty	5 years	
Certification	CE (Under Certification)	

Installation Accessories	
Recessed accessory	RB-02 L68.5xW35xH31.6mm
Accessory package	BG-02
Whole luminaire splicing bar	EX-17

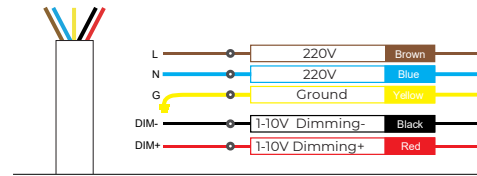

Model Code

Model Number	Installation	Section Size	Diffuser Shape	Diffuser Nature	Carrier Style	Profile Colour	End Cap Style	Length	Version	Light Source Type	Light Source Power	CCT	CRI	Power Type
GCCHA-GLLS-GBE6935-27W-1200	-	BE 69 Series	Flat	F	Diffuse D	Flat	F	Silver S	Standar end cap	S	1200mm	/	-	Constant Current Rigid
GCCHA-GLLS-GBE6935-38W-1800	-	6935				White W		1800mm	High efficiency (H)		38W	38	3000K	WW >90 9 DALI dimming
GCCHA-GLLS-GBE6935-53W-2400	-					Black B		2400mm	Emergency power (E)		53W	53	3500K	PW No dimming
GLLS	-	BE 6935	F	D	F	S	S	1200	-	T	27	NW	8	B

GBE9435 NEW



- AL6063-T5 aluminum profile with high-quality surface treatment
- Three optional colours of black/white/silver.
- LM80 certified light source, bridgelux LED, life >50000H
- Built-in efficient and safe flicker-free dimming power supply, Support 1-10V dimming or Dali dimming

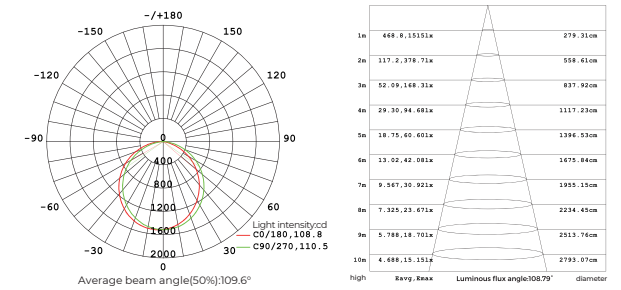
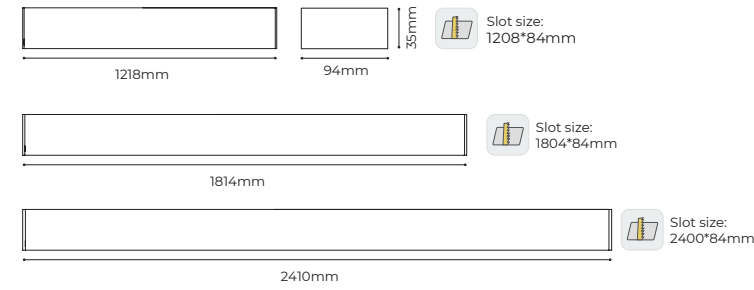
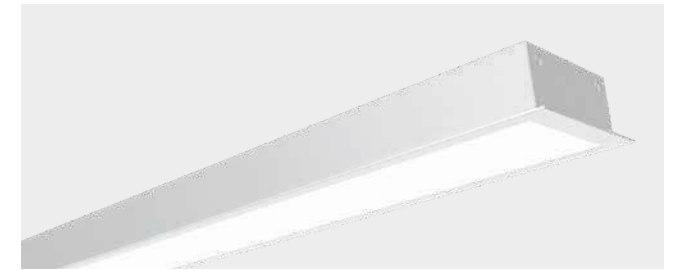

Luminaire Parameter		
Diameter	1198*94*35mm	1794*94*35mm
Diffuser Type	Diffuser	
Diffuser Material	PC	
Luminous Flux	4250LM	6710LM
Luminous flux (high luminous effect)	4940LM	7800LM
Power	38W	60W
Color Temperature	2700K/3000K/3500K/4000K/5000K/6500K	
CRI	>80, >90	
Light-emitting Angle	110°	
Input Voltage	200-240VAC 50Hz/60Hz	
Power Factor	>0.9	
Power Supply	Built-in isolated power	
Light-tuning Method	Non-dimming/1-10V/DALI/CCT dial switch	
Colour	Silver <input type="radio"/> White <input type="radio"/> Black <input type="radio"/>	
Installation Method	Edged Embedding	
Warranty	5 years	
Certification	CE (Under Certification)	

Installation Accessories	
Recessed accessory	RB-02 L68.5xW35xH31.6mm
Accessory package	BG-02
Whole luminaire splicing bar	EX-17

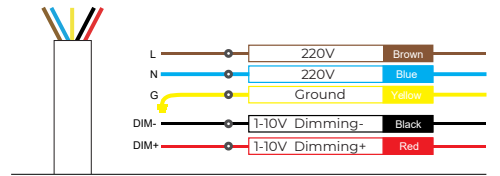

Model Code

Model Number	Installation	Section Size	Diffuser Shape	Diffuser Nature	Carrier Style	Profile Colour	End Cap Style	Length	Version	Light Source Type	Light Source Power	CCT	CRI	Power Type
GCCHA-GLLS-GBE9435-27W-1200	-	BE 94 Series	Flat	F	Diffuse D	Flat	F	Silver S	Standar end cap	S	1200mm	/	-	Constant Current Rigid
GCCHA-GLLS-GBE9435-38W-1800	-	9435				White W		1800mm	High efficiency (H)		60W	38	3000K	WW >90 9 DALI dimming
GCCHA-GLLS-GBE9435-53W-2400	-					Black B		2400mm	Emergency power (E)		75W	53	3500K	PW No dimming
GLLS	-	BE 9435	F	D	F	S	S	1200	-	T	38	NW	8	B

Lighting Application Guidelines

GBS3360/GBH3360/GBE5535

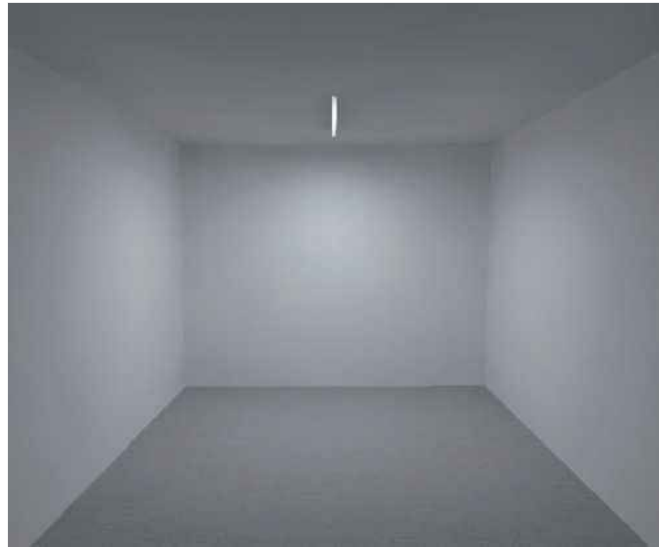

Downward Lighting Type, installation height is 2800mm. Average desktop illuminance in the area of 2000x1400mm directly below the luminaire is 200lx.

Upward and downward lighting Type, installation height is 2800mm. Average desktop illuminance in the area of 2000x1400mm directly below the luminaire is 200lx, while that in ceiling directly above the luminaire is 150lx.

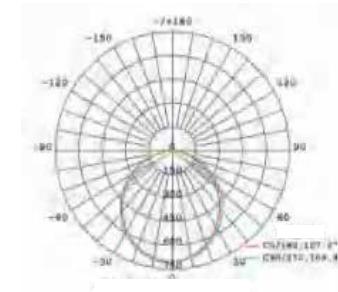
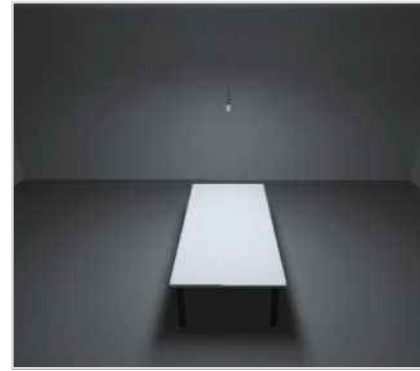

Downward Lighting:

Installation Height of 2.8m;
Average desktop illumination 200lx
The width of the table top is 1.4m,
and the length is the same as that of the lamp;

Luminous flux : 2000lm
Light-emitting Angle: 110°
Peak Luminous Intensity: 705cd

Luminaire Size : 1198*33*60mm
Installation Height : 2500mm/2800mm
Desktop Height: 750mm

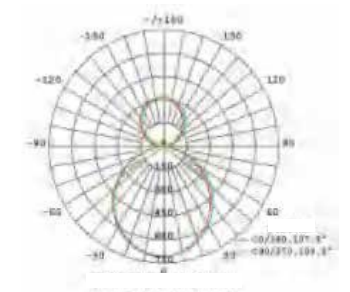
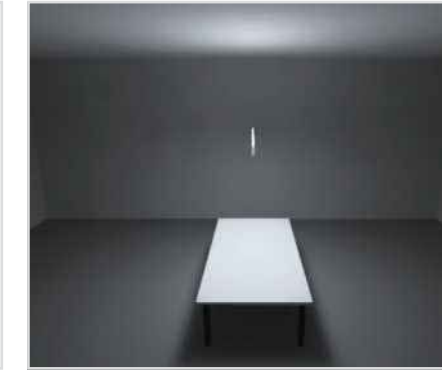

Upward And Downward Lighting:

Installation Height, Average Desktop Illuminance
Desktop Width 1.4m, The same length as luminaire
Illuminance Ratio of ceiling to desktop is 2:1

Luminous flux : 2750lm
Light-emitting Angle 110°
Peak Luminous Intensity

Luminaire Size : 1198*33*60mm
Installation Height : 2600mm/2800mm
Desktop Height: 750mm

GBS5470/GBH5470/GBE6935

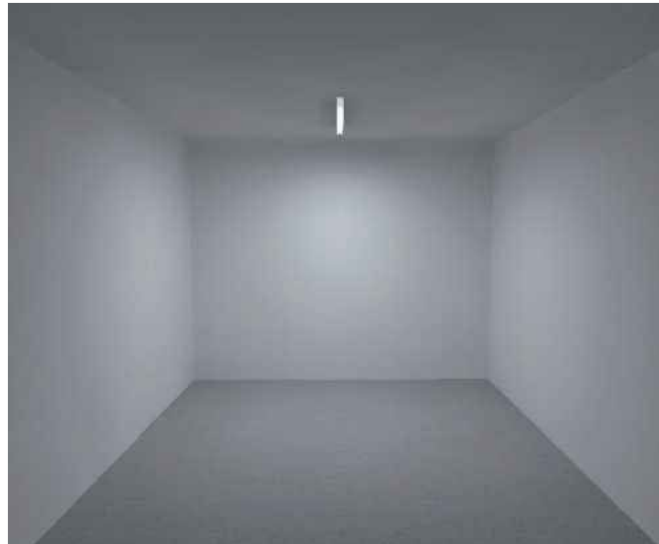

Downward Lighting Type, installation height is 2800mm. Average desktop illuminance in the area of 2000x1400mm directly below the luminaire is 350lx.

Upward and downward lighting Type, installation height is 2800mm. Average desktop illuminance in the area of 2000x1400mm directly below the luminaire is 200lx, while that in ceiling directly above the luminaire is 200lx.

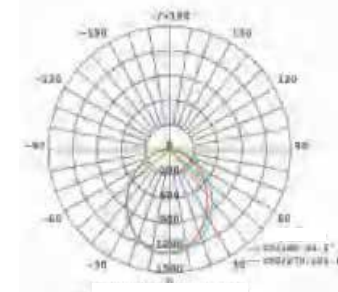
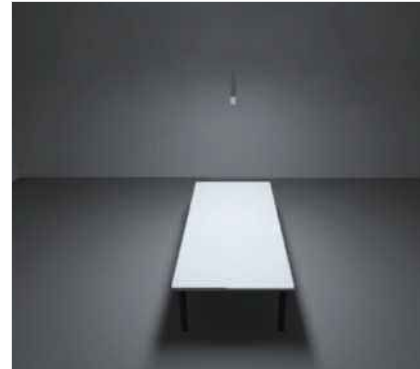

Downward Lighting:

Installation Height of 2.8m;
The average desktop illumination is 350lx;
The width of the table top is 1.4m,
and the length is the same as that of the lamp;

Luminous flux : 2940lm
Beam angle: 100°
Peak light intensity: 1270cd

Lamp size: 1198*54*70mm
Installation height: 2500mm/2800mm
Working surface height: 750mm

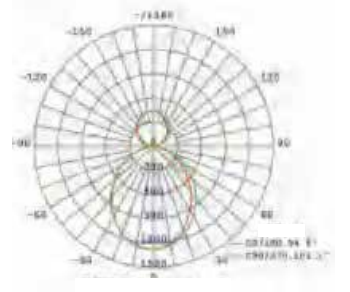
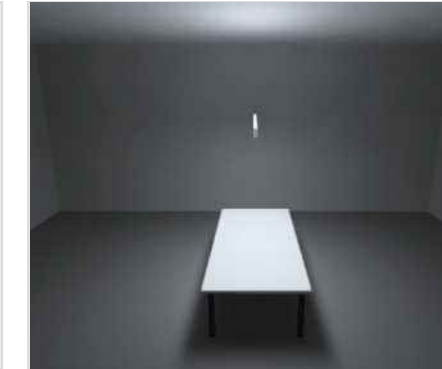

Upward And Downward Lighting:

Installation height 2.8m; average desktop illumination 350lx;
The width of the table top is 1.4m, and the length
is the same as that of the lamp;
The illuminance ratio of the ceiling to the table top is 4:7;

Luminous flux 3960lm
Beam angle: 100°
Peak light intensity: 1275cd

Lamp size: 1198*54*70mm
Installation height: 2500mm/2800mm
Working surface height: 750mm

GBS37977/GBH7977/GBE9435

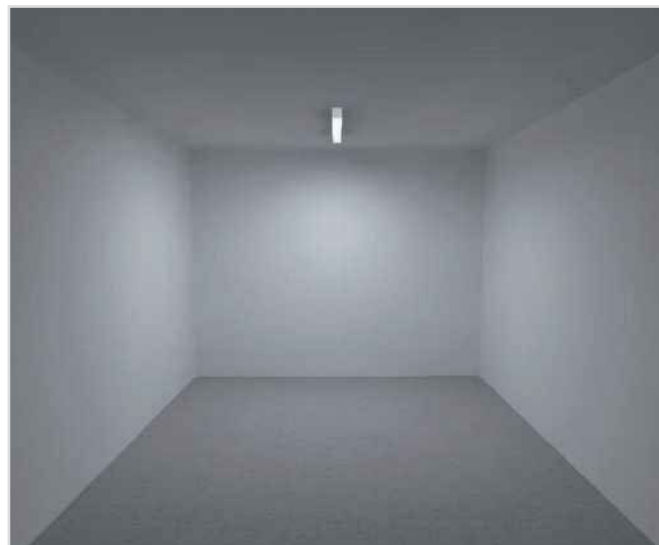

Downward Lighting Type, installation height is 2600mm. Average desktop illuminance in the area of 2000x1400mm directly below the luminaire is 500lx.

Upward and downward lighting Type, installation height is 2600mm. Average desktop illuminance in the area of 2000x1400mm directly below the luminaire is 500lx, while that in ceiling directly above the luminaire is 2500lx.

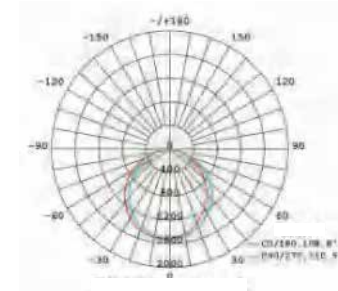
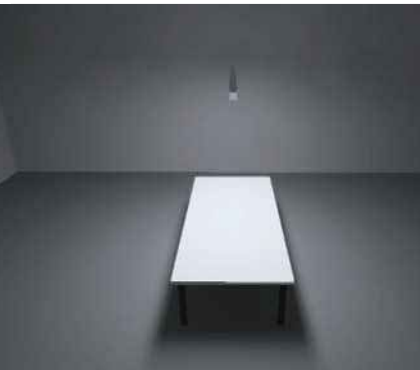

Downward Lighting:

Installation height of 2.6m;
The average desktop illumination is 500lx;
The width of the table top is 1.4m, and the
length is the same as that of the lamp;

Luminous flux: 4290lm
Beam angle: 110°
Peak light intensity: 1519cd

Lamp size: 1198*79*77mm
Installation height: 2600mm/2800mm
Working surface height: 750mm

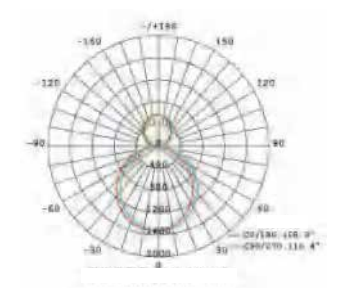
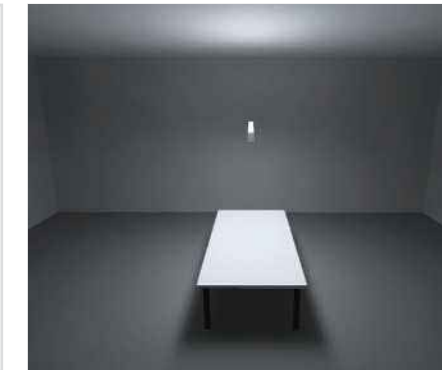

Upward And Downward Lighting:

Installation height 2.6m; average desktop illumination 500lx;
The width of the table top is 1.4m, and the length
is the same as that of the lamp;
The illuminance ratio of the ceiling to the table top is 12;

Luminous flux 5570lm
Beam angle: 110°
Peak light intensity: 1526cd

Lamp size: 1198*79*77mm
Installation height: 2600mm/2800mm
Working surface height: 750mm



Greenlux Lighting

37 Chelmsford Street,
Williamstown North VIC 3016 Australia

Ph: 1300 650 625 / +61 3 8560 2895

Email: enquiries@greenlux.com.au

Website: www.greenlux.com.au