

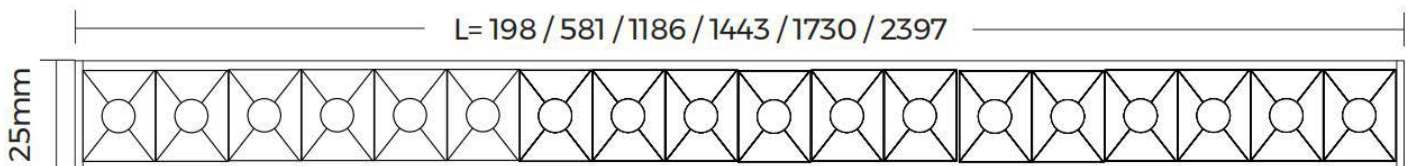

greenlux
cost reduction LED lighting

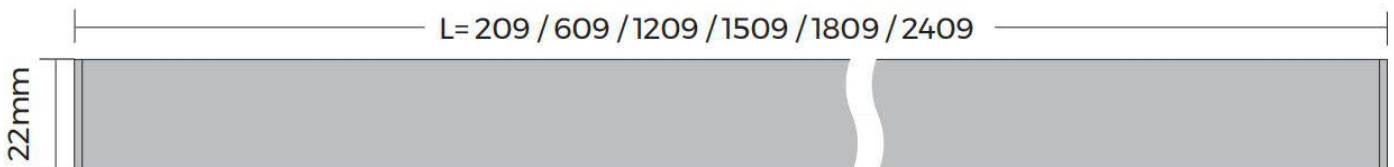

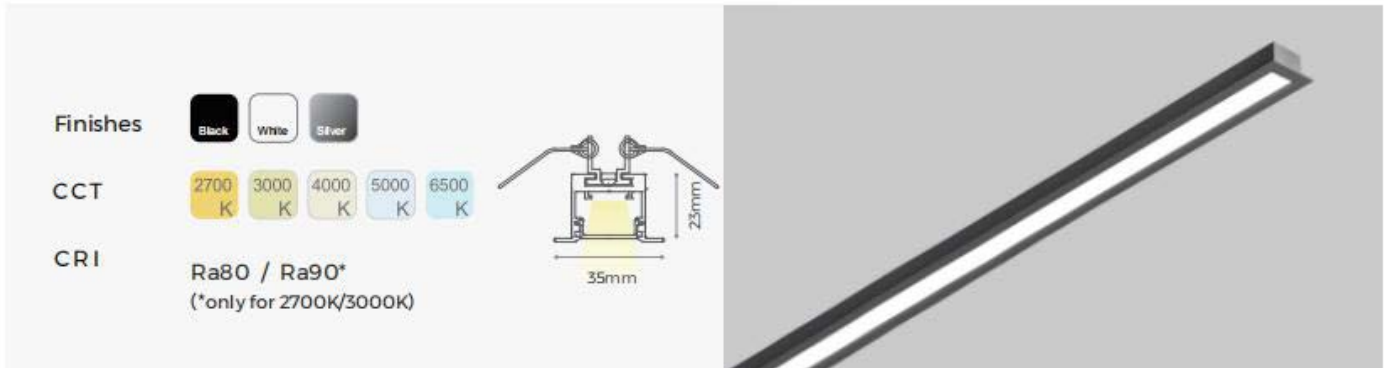

Chain GLE25 Recessed



- Multiple Light Distribution Options:
Diffuser / Microprism / Grating 30° & 60° / Asymmetric / Double Asymmetric
- 25mm Slim Lighting Surface
- High Efficiency 125lm/W, Lumen Output Up To 2300lm/m
- Butterfly Clip Design for Easy Installation

Chain GLE25 Recessed

Optical & Electronic Data

Model	Size	 Diffuser	 Microprism	 Grating 30°	 Grating 60°	 Asymmetric	 Double asymmetric	 Blind cover
GCCHA-GLE25-4W	190mm	4W / 400LM	4W / 400LM	4W / 300LM	4W / 250LM	4W / 500LM	4W / 500LM	/
GCCHA-GLE25-12W	600mm	12W / 1250LM	12W / 1250LM	12W / 850LM	12W / 700LM	12W / 1500LM	12W / 1500LM	/
GCCHA-GLE25-24W	1200mm	24W / 2500LM	24W / 2500LM	24W / 1700LM	24W / 1400LM	24W / 3000LM	24W / 3000LM	/
GCCHA-GLE25-30W	1500mm	30W / 3150LM	30W / 3150LM	30W / 2100LM	30W / 1800LM	30W / 3750LM	30W / 3750LM	/
GCCHA-GLE25-36W	1800mm	36W / 3750LM	36W / 3750LM	36W / 2500LM	36W / 2300LM	36W / 4500LM	36W / 4500LM	/
GCCHA-GLE25-48W	2400mm	48W / 5000LM	48W / 5000LM	48W / 3500LM	48W / 3100LM	48W / 6000LM	48W / 6000LM	/
GCCHA-GLE25-L	L* (277*277mm)	11W / 1155LM	11W / 1155LM	/	/	/	/	Available
GCCHA-GLE25-T	T* (529*277mm)	16W / 1680LM	16W / 1680LM	/	/	/	/	Available
GCCHA-GLE25-X	X* (529*529mm)	21W / 2205LM	21W / 2205LM	/	/	/	/	Available

Remark:

1. The tolerance of output data can be vary up to 10%
2. The output data is a typical value

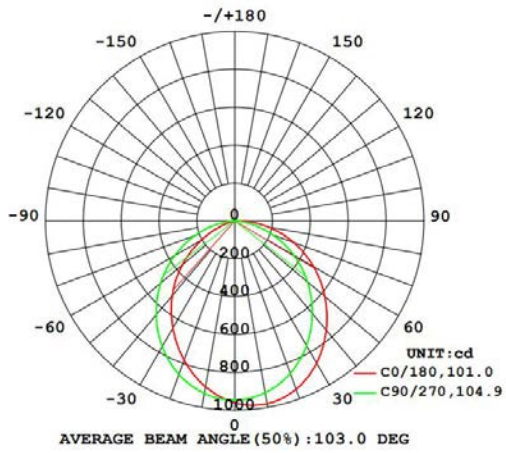

1.2m luminaire with Diffuser

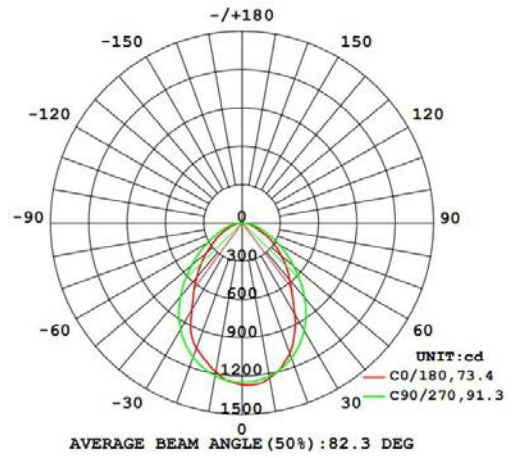

1.2m luminaire with Microprism

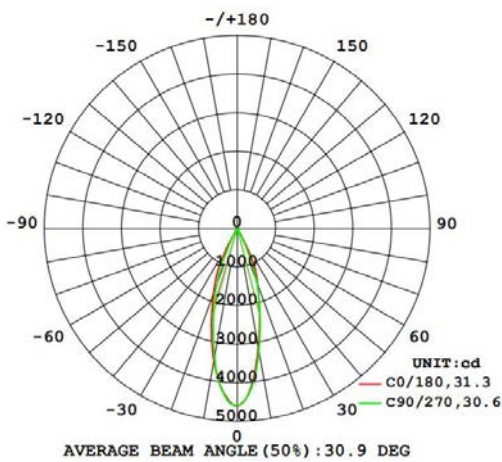

1.2m luminaire with Grating 30°

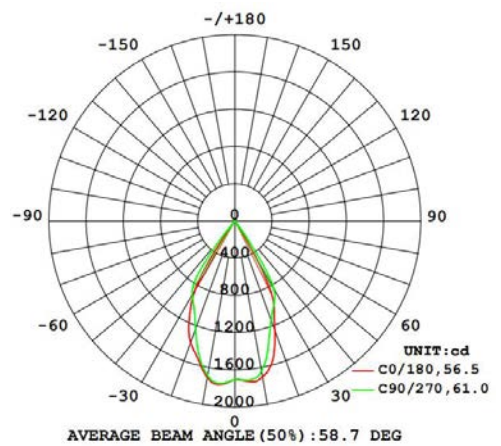

1.2m luminaire with Grating 60°

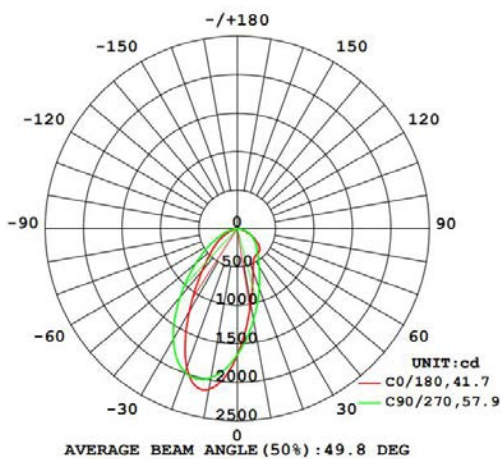

1.2m luminaire with Asymmetric

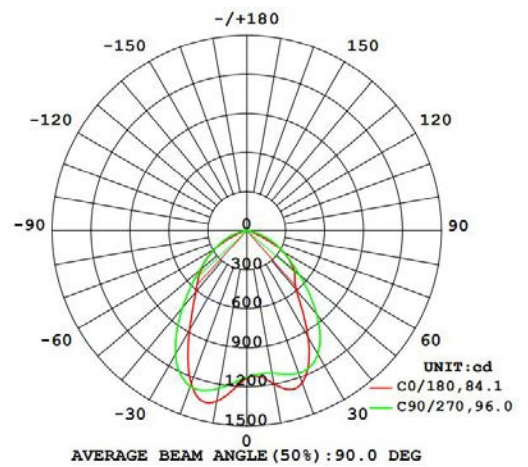

1.2m luminaire with Double Asymmetric