



greenlux
cost reduction LED lighting

Corona Series LED Downlight

Available in Multiple Wattage
80% lumen maintenance at 50,000 hours

- No UV or IR rays. No mercury
- Low UGR <19
- Dimmable and Non-Dimmable option available
- Superb dimming effect
- COB LED chips with high luminous flux
- Die-cast aluminum alloy housing provides excellent thermal dissipation
- Transparent or frosted glass cover for option, anti-glare glass
- IP20 Rated
- 3 Years Warranty
- Applications include restaurants, offices, shops, schools, hotels & households. Also widely used for public areas such as stairways, lobby, receptions & corridors.



Specifications

Colour Range	3000-6000k
Power Consumption	9W ~ 35W
Lumen	90lm/W
Input Voltage	AC 100-240V 50/60Hz
Operating Temp.	-20°C to 45°C
Dimming Range	10% ~ 100%
Beam angle	50° / 60° / 80°
Ra	>80
Power Factor	>0.9
Chipset	COB
Driver	Class II
IP Rating	IP20
Dimmable	Triac, 0-10V or Dali (option)

Dimensions & Materials

Product Dimensions (mm)	3"	Ø100*53
	4"	Ø118*62
	6"	Ø170*86
	8"	Ø230*106
Cutout Dimensions (mm)	3"	Ø80
	4"	Ø100
	6"	Ø150
	8"	Ø200
Housing Material	Aluminum Alloy Housing	
Cover	Frosted or Clear	

Certification and Safety

Certifications	CE, RoHS, SAA, RCM
Environment	Indoor Location
Warranty	3 years





greenlux
cost reduction LED lighting

Corona Series LED Downlight

Available in Multiple Wattage
80% lumen maintenance at 50,000 hours

Dimensions

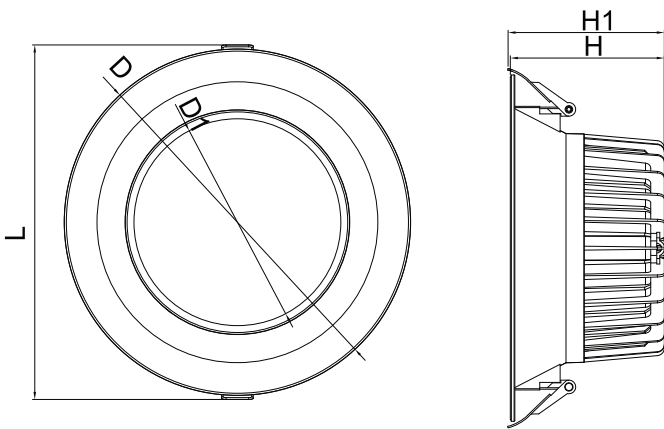

	3inch	4inch	6inch	8inch
D	100mm	118mm	170mm	230mm
D1	50.7mm	57.6mm	104.2mm	137mm
H	49.5mm	60mm	80.5mm	102mm
H1	53mm	62mm	86mm	106mm
L	105mm	123mm	177mm	235mm

Photometrics

9W 4000k

LUMINOUS INTENSITY DISTRIBUTION DIAGRAM

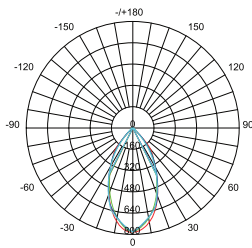

AVERAGE BEAM ANGLE(50%):53.8 DEG

12W 4000k

LUMINOUS INTENSITY DISTRIBUTION DIAGRAM

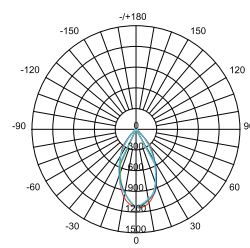

AVERAGE BEAM ANGLE(50%):53.5 DEG

15W 4000k

LUMINOUS INTENSITY DISTRIBUTION DIAGRAM

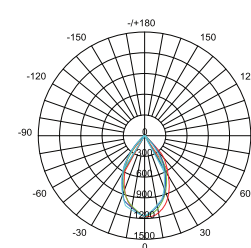

AVERAGE BEAM ANGLE(50%):60.5 DEG

18W 4000k

LUMINOUS INTENSITY DISTRIBUTION DIAGRAM

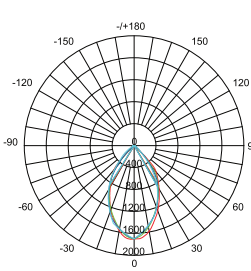

AVERAGE BEAM ANGLE(50%):62.1 DEG

25W 4000k

LUMINOUS INTENSITY DISTRIBUTION DIAGRAM

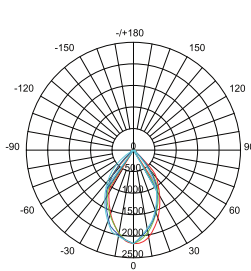

AVERAGE BEAM ANGLE(50%):65.2 DEG

30W 4000k

LUMINOUS INTENSITY DISTRIBUTION DIAGRAM

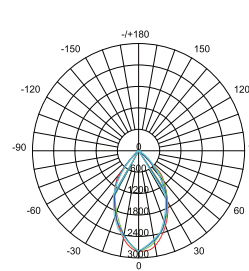

AVERAGE BEAM ANGLE(50%):62.2 DEG

35W 4000k

LUMINOUS INTENSITY DISTRIBUTION DIAGRAM

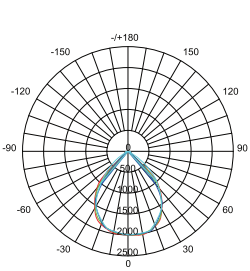

AVERAGE BEAM ANGLE(50%):82.8 DEG



greenlux
cost reduction LED lighting

Corona Series LED Downlight

Available in Multiple Wattage
80% lumen maintenance at 50,000 hours

Model

Model#	CCT	LED Type	Lumen(lm)	Dimension (mm)	Cutout Size (mm)	Dimmable (option)	Voltage(V)
GSCOR-9W 3"	3000K 4000K 5000K	COB	690	100*53	80	Triac 0-10V Dali	AC100-240V
GSCOR-12W 3"			1000	100*53	80		
GSCOR-15W 4"			1150	118*62	100		
GSCOR-18W 4"			1700	118*62	100		
GSCOR-18W 6"			1700	170*86	150		
GSCOR-25W 6"			2350	170*86	150		
GSCOR-25W 8"			2350	230*106	200		
GSCOR-30W 8"			2700	230*106	200		
GSCOR-35W 8"			3150	230*106	200		

Light CCT Guide

