

Chain GLS Series



GLS 1911P



- "Dot-free" lighting source producing homogeneous & soft lights
- Aluminum profile with excellent heat dissipation performance
- High quality surface treatment and PC diffuser
- Optional end caps with or without hole
- Free & flexible connection

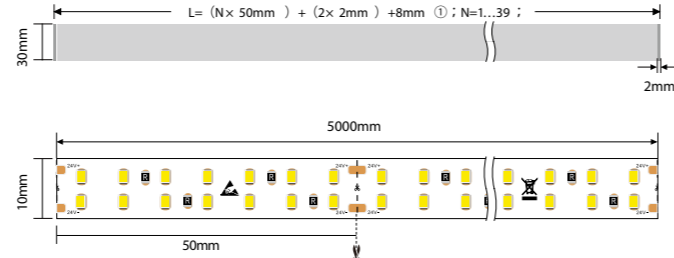
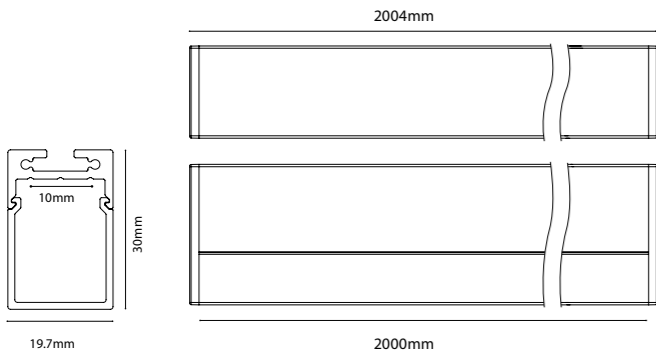
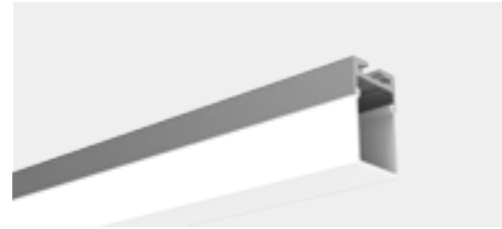

① For wiring

Profile flexible cutting size:

$$L_{min} = (1 \times 50\text{mm}) + (2 \times 2\text{mm}) + 8\text{mm} \text{ ①} = 62\text{mm}$$

$$L_{max} = (39 \times 50\text{mm}) + (2 \times 2\text{mm}) + 8\text{mm} \text{ ①} = 1962\text{mm}$$

Recommended grooving size:

W=21mm, H=11mm



Profile Components ①		
Profile × 1	PR-GLS1911(B) 19.7× 11× 2000mm	
End cap × 4	EC-GLS1911P(B)SN 19.7× 30× 5mm	
Diffuser × 1	CV-GLS1911P(B) 19.7× 2× 2000mm	
Mounting clip × 4	GCP-07 38× 15× 4.5mm	

Optional Accessories		
End cap with hole × 2	EC-GLS1911P(B)SH 19.7× 30× 5mm	
Pendant cable (with junction box)	GPY-SSXX 2m/4m	
Pendant cable	GPN-SXX 2m/4m	
180° extender	GEX-05 55× 10× 2mm	

①Parts of profile components can be purchased separately

②The luminous flux is the testing result of 4000K product

PHOTOMETRIC OF 1M LUMINAIRE (D6280H-24V-10mm)

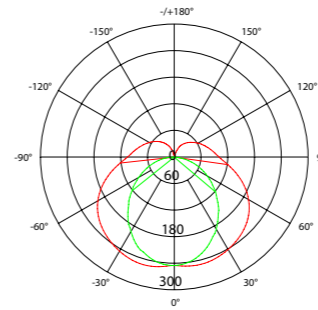

Height	Eavg,Emax	Angle:135.00deg	Diameter
1m	36.90,244.1lx		482.84cm
2m	9.225,61.03lx		965.69cm
3m	4.100,27.12lx		1448.53cm
5m	1.476,9.764lx		2414.21cm
7m	0.7531,4.982lx		3379.90cm

Lighting Source and Power Supply

Flexible Strip

Model	CR	Lumens ②	Voltage	Typ.power	Size	LEDs/m	Cutting unit
GD6280L-24V-10mm	>90	850LM/m	24V	8W/m	5000 × 10× 1.2mm	280LEDs	14LEDs/50mm
GD6280H-24V-10mm	>90	1600LM/m	24V	15W/m	5000 × 10× 1.2mm	280LEDs	14LEDs/50mm

Power Supply

Model	Size	Input voltage	Input current	Output voltage	Output power	Dimming method	Power factor
GESD-V24-025S	330 × 2× 20mm	100-277VAC 50/60Hz	0.35A Max	24VDC	25W	PWM、0-10V、Resistor	>0.95
GESD-V24-065S	363 × 34.5 × 22.5mm	100-277VAC 50/60Hz	1.0A Max	24VDC	65W	PWM、0-10V、Resistor	>0.95
GSN-V24-065S	400 × 24.5 × 22mm	200-240VAC 50/60Hz	0.4A Max	24VDC	65W	on/off	>0.95
GESD-V24-100S	390 × 38 × 28.5mm	100-277VAC 50/60Hz	1.6A Max	24VDC	100W	PWM、0-10V、Resistor	>0.95
GSN-V24-100S	420 × 30.5 × 26mm	200-240VAC 50/60Hz	0.6A Max	24VDC	100W	on/off	>0.95

Controller

Model	Size	Input voltage	Load power	Working temperature	Detecting distance
GCM1-RID-B1	64.5 × 16× 13mm	12V-24V	30W/60W(12V/24V)	-20° ~40°	5-8cm
GCM2-CID-B1	64.5 × 16× 13mm	12V-24V	30W/60W(12V/24V)	-20° ~40°	-
GOMB-CZDT-B1	64.5 × 16× 13mm	12V-24V	25W/50W(12V/24V)	-20° ~40°	-

Furniture Lighting

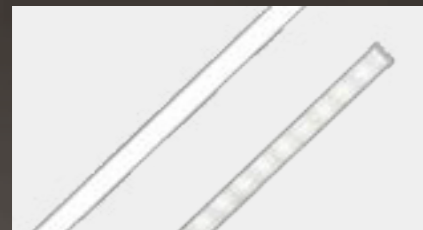

Dot-free Light Source:
Perfect homogenous lighting distribution.

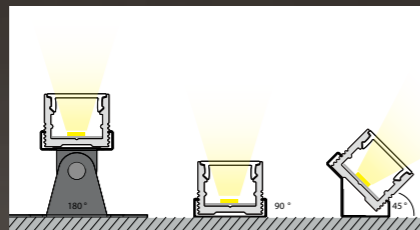

Multiple Emission Angles:
45°, 90°, or 0-180° adjustable

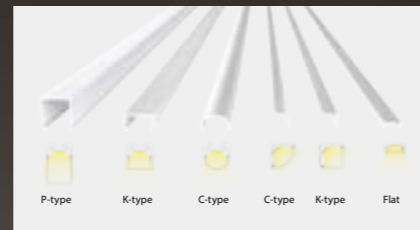

Various Diffusers:
Several optional diffusers; Various shapes and light distribution.

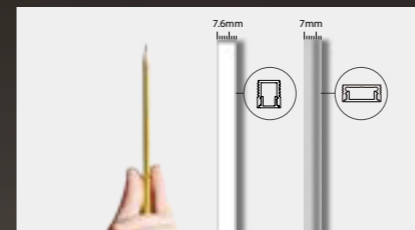

Small size for various application:
Super slim and compact